

**NORT**wood



2024 Collection



**D**SOAL

P 2

Tools & Safety

P 3

Color Collection

P 4-5-6

**Fluted Panel**

P 7

Subframe Requirements

P 8-9-10-11

Installation

P 14

Miter Cut Techniques

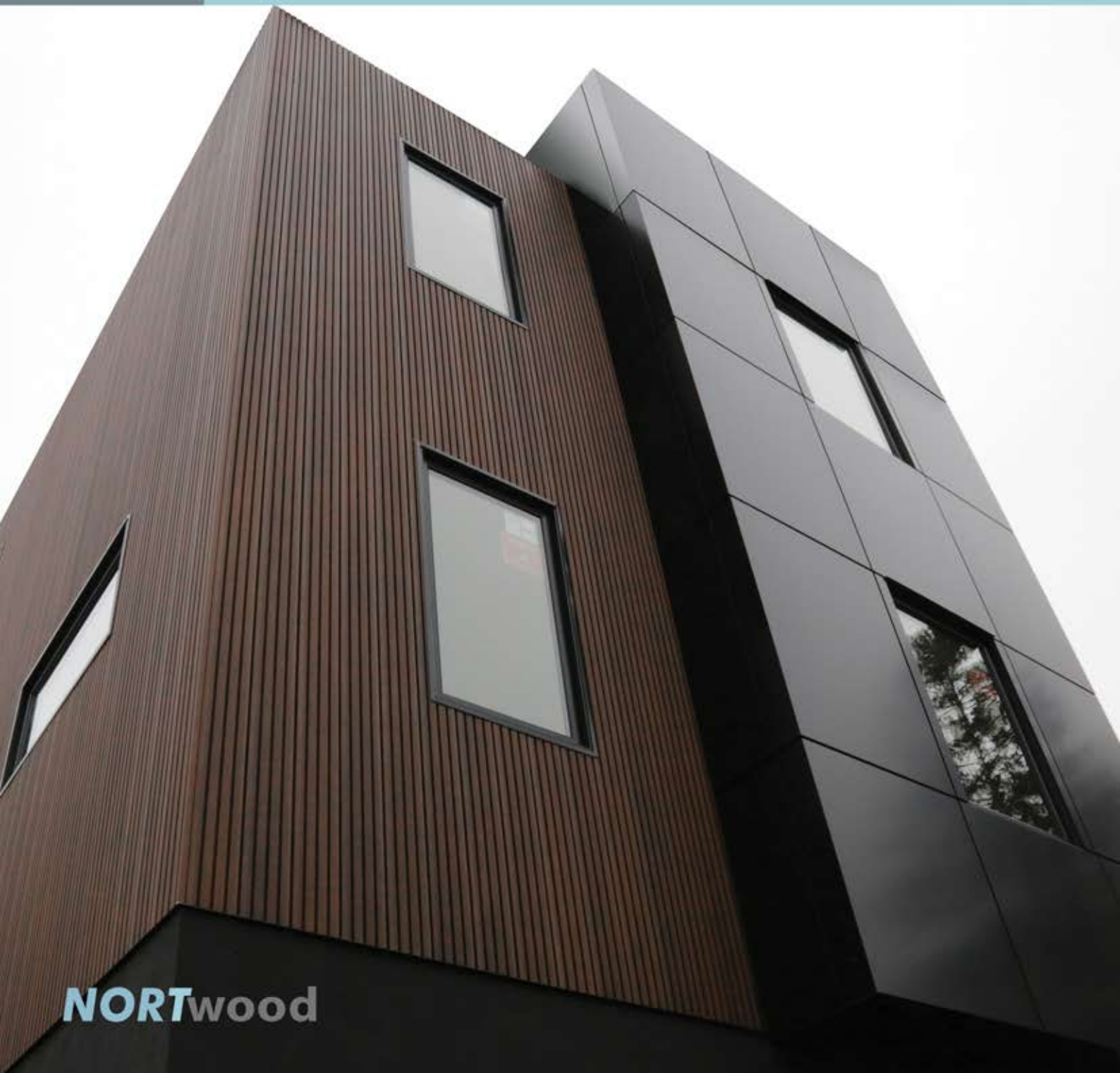

# NORR



## Tools & Safety

Always remember to wear appropriate personal protective equipment (PPE), including eye and hearing protection. Utilize standard wood-cutting tools such as a table saw and miter saw equipped with a carbide blade (60-80 tooth), a jig saw, a hole saw, and a drill for attachments



## NORTwood Color Collection



Charcoal Black



Deep Gray



Norway Teak



Brazil Ipe



Golden Maple



Canada Oak



Antique Gray

## Product Description

**NORT**wood Tongue & Groove Siding is an extruded WPC closed joint rainscreen siding system, designed to be installed horizontally or vertically.

Panels are available in standard lengths of 142" as well as trim Components, used for end captures such as along the 12' bottom and top of walls, around windows and doors, corners, end terminations and expansion.

Before installing **NORT**wood Cladding product, it is recommended that you check with local building codes for any special requirements or restrictions. All Pictures shown are for illustration purposes only and are not intended to provide a specific work order for installation.

Any construction or use of **NORT**wood panels must be in accordance with all local zoning and/or building codes.

The consumer assumes all risks and liability associated with the construction and use of this product.



General questions:

What are Fluted Panels?

Fluting is a type of moulding finish in which squared moulding is repeated in a pattern. These are more refined versions of slat walls.

What Are **NORT**wood Fluted Panels Made Of?

**NORT**wood Fluted panels are engineered from wood fibres with a polyethylene density, **NORT**wood plastic composite looks like natural wood with linear or vertical designs. The material is moisture, pest, and mould-resistant.

What Are Fluted Panels Used For?

Fluted panels are great as extra décor features on modern homes, hotels lobbies, conference rooms, reception areas, and any space that requires something luxury.

# ECO 25

NORTwood Fluted Panel



25mmx163mm x3600mm | 2.5 Kg/m  
(1"x 6 1/2" x 142")

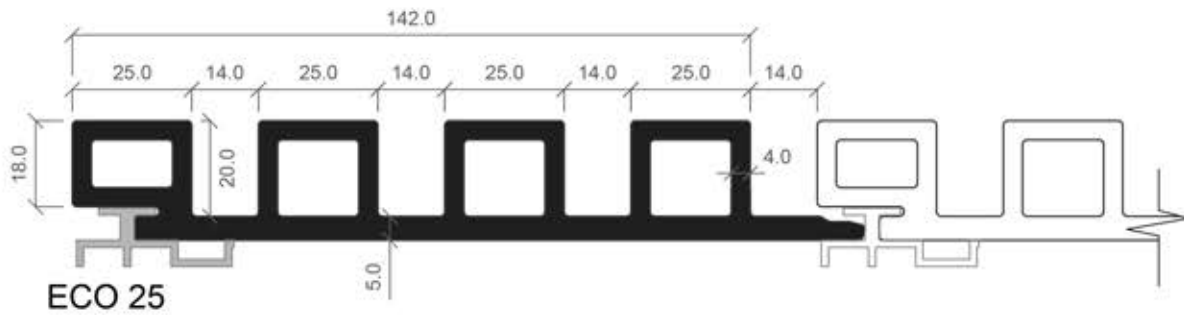





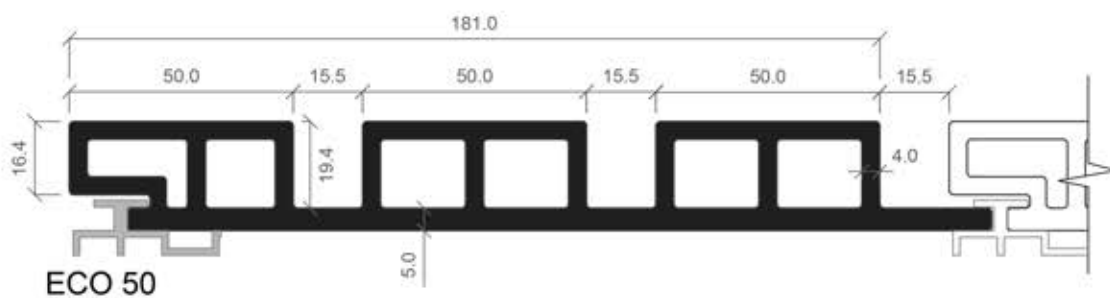

# ECO 50

NORTwood Fluted Panel

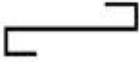

26x208mm x3600mm | 2.2 Kg/m  
(1"x 8 1/2" x 142")



Product	Material		Part
Corner & End Clip	Satinless Steel		
Panel Clip	Aluminum		
Starter	Aluminum Profile		
End Trim	WPC		
Corner Trim	WPC		
L Trim	WPC		

Please be aware that in order to achieve an architectural exposed appearance and eliminate the necessity for extra trims, NORTwood panels can be readily cut and mitered for corner installations.



# Subframe Requirements

## Wood or Steel Strapping

The studs need to have a minimum thickness of 1 inch (25 mm). Straps should be fixed into position at a maximum of 16 inches (400 mm) centers using a suitable Stainless Steel Countersunk Wood/Masonry screw. All studs need to be flat and leveled against the wall surface use shims if necessary. Architects should be consulted regarding weather barriers and insulation for your project. Where a weather barrier is to be used, it should be a breathable type and must be positioned behind the studs.

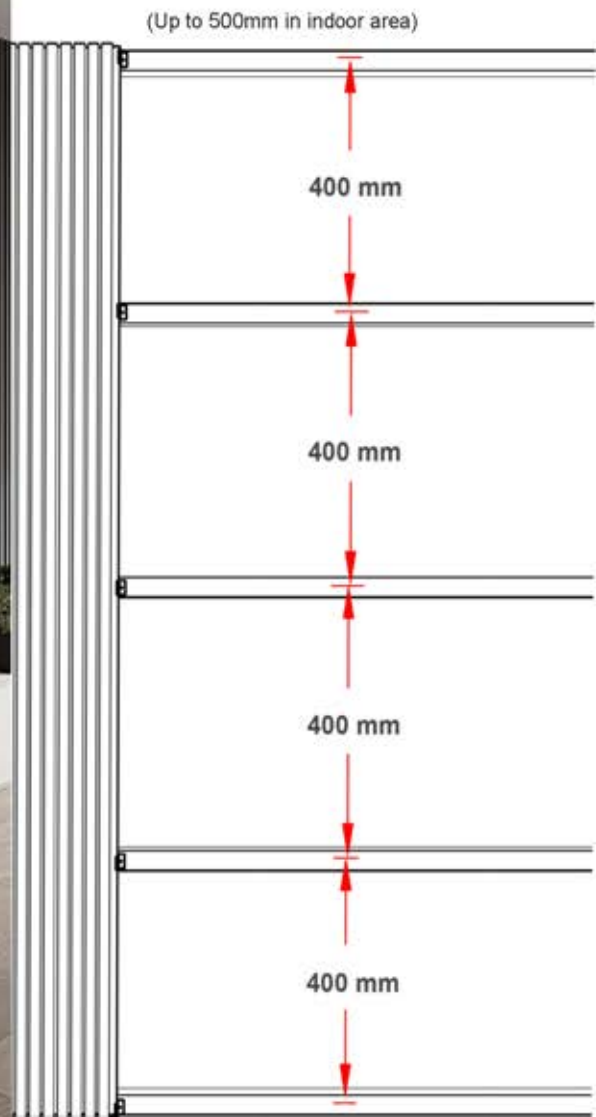



## Clips Fastening

Aluminum Clips should be hard fastened every 600mm directly through the panels.

#8 pan-head screws are recommended.

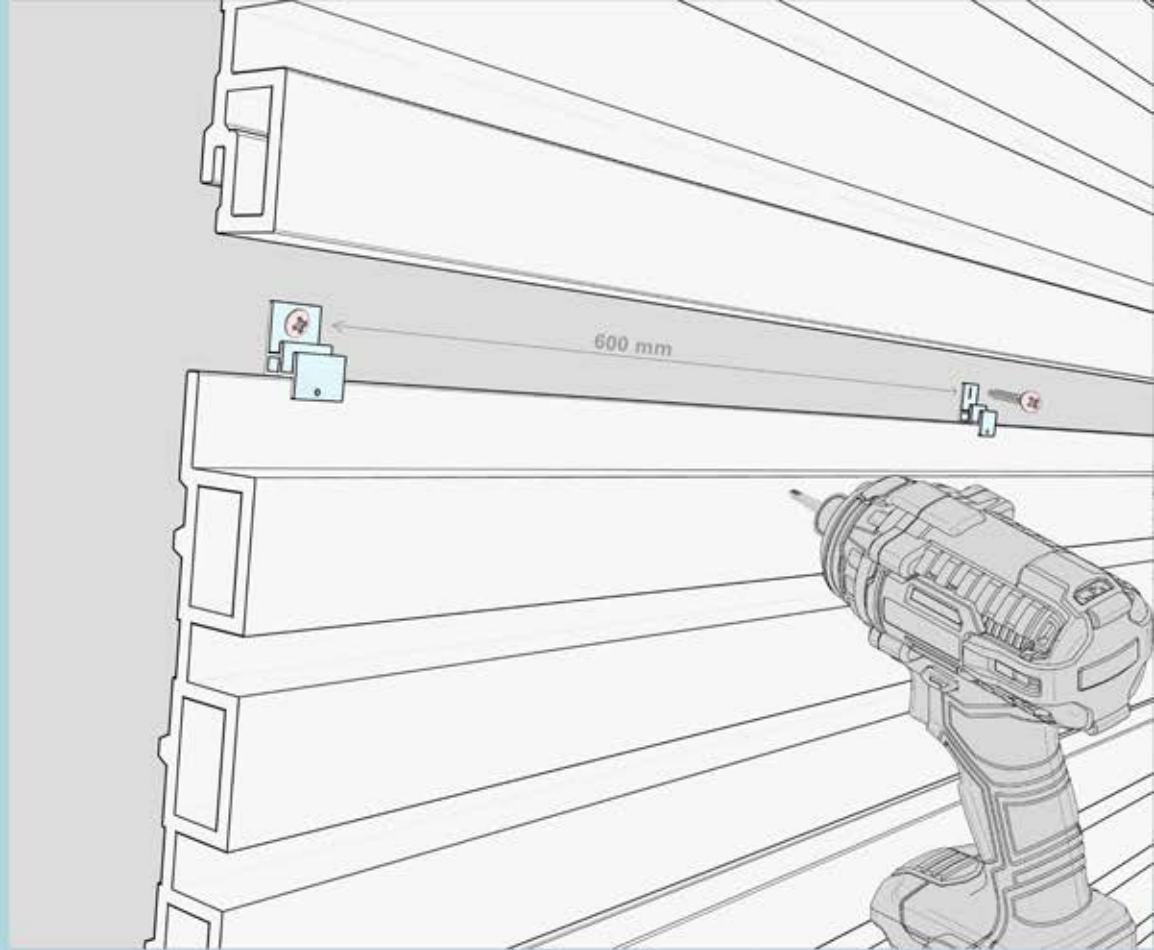

All fasteners should be suitable for exterior use and be compatible with the substrate type.

Used when locking the panels and installing into wood straps



Used when locking the panels and installing into metal studs



Starter

Bottom Flashing

Panels & Starter components are secured using **NORTwood Clips** (Fastened every 400mm (16") to the substrate).

Top Panel Detail

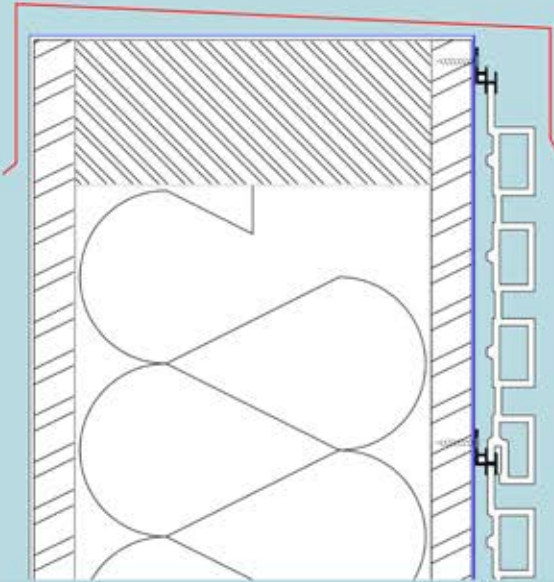

NORT

Inside Corner

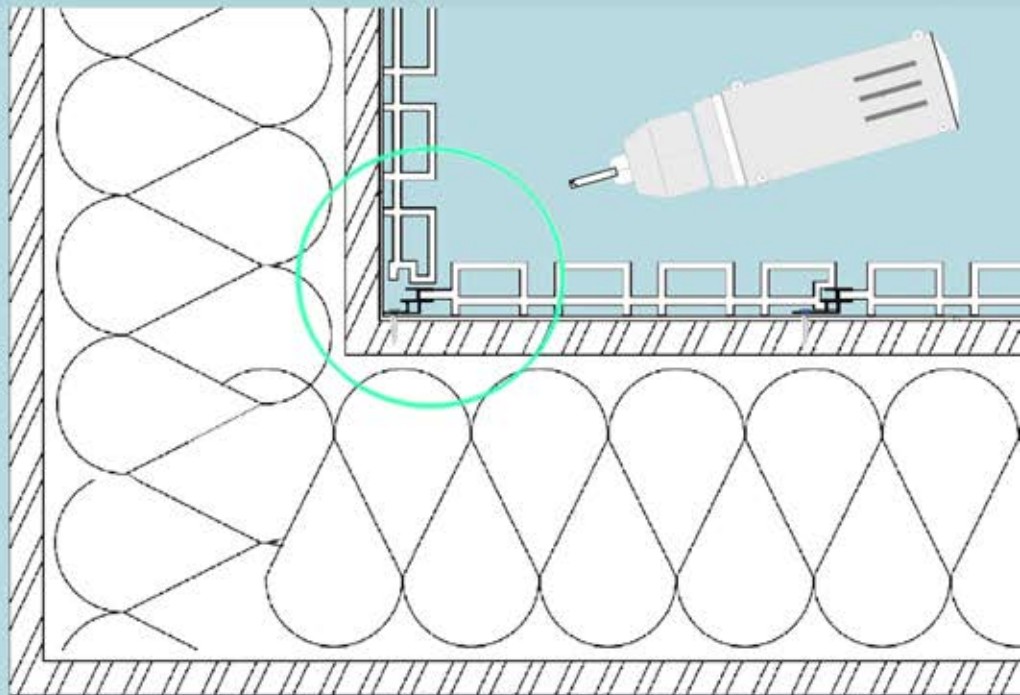

# Architectural Corner Ideas

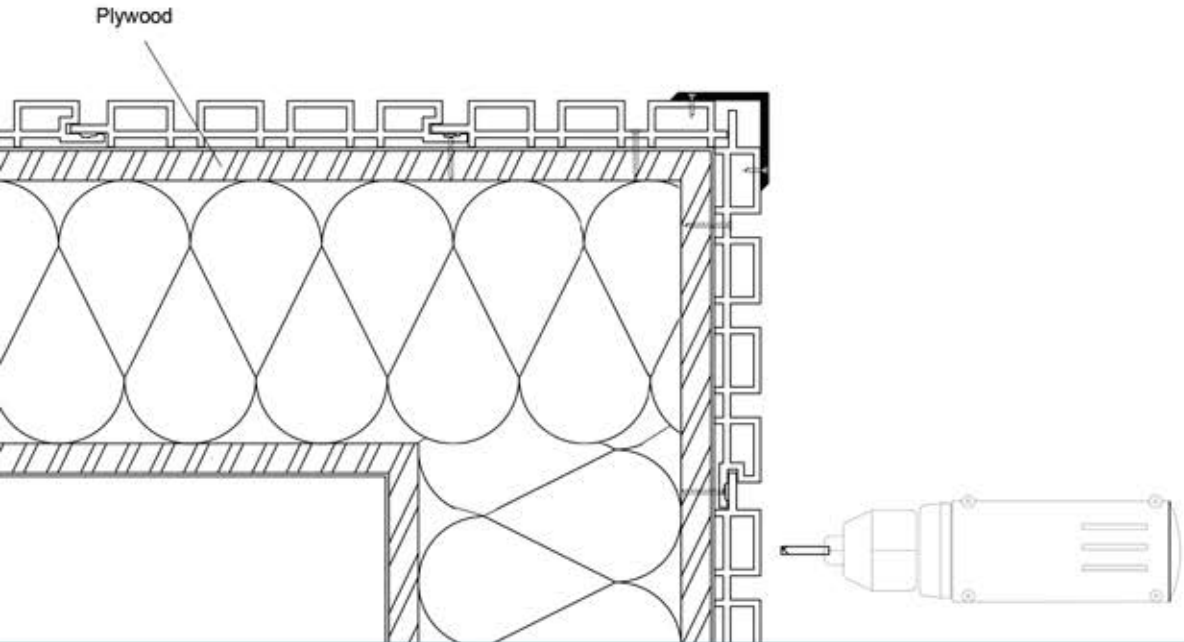

## L Trim Corner



# Outside Corner Trim



**Place** the trim board on the perpendicular wall and adjust it so that one edge is flush with the surface of the panels. Hold it in place with two finish nails then screw to the wood or steel studs.

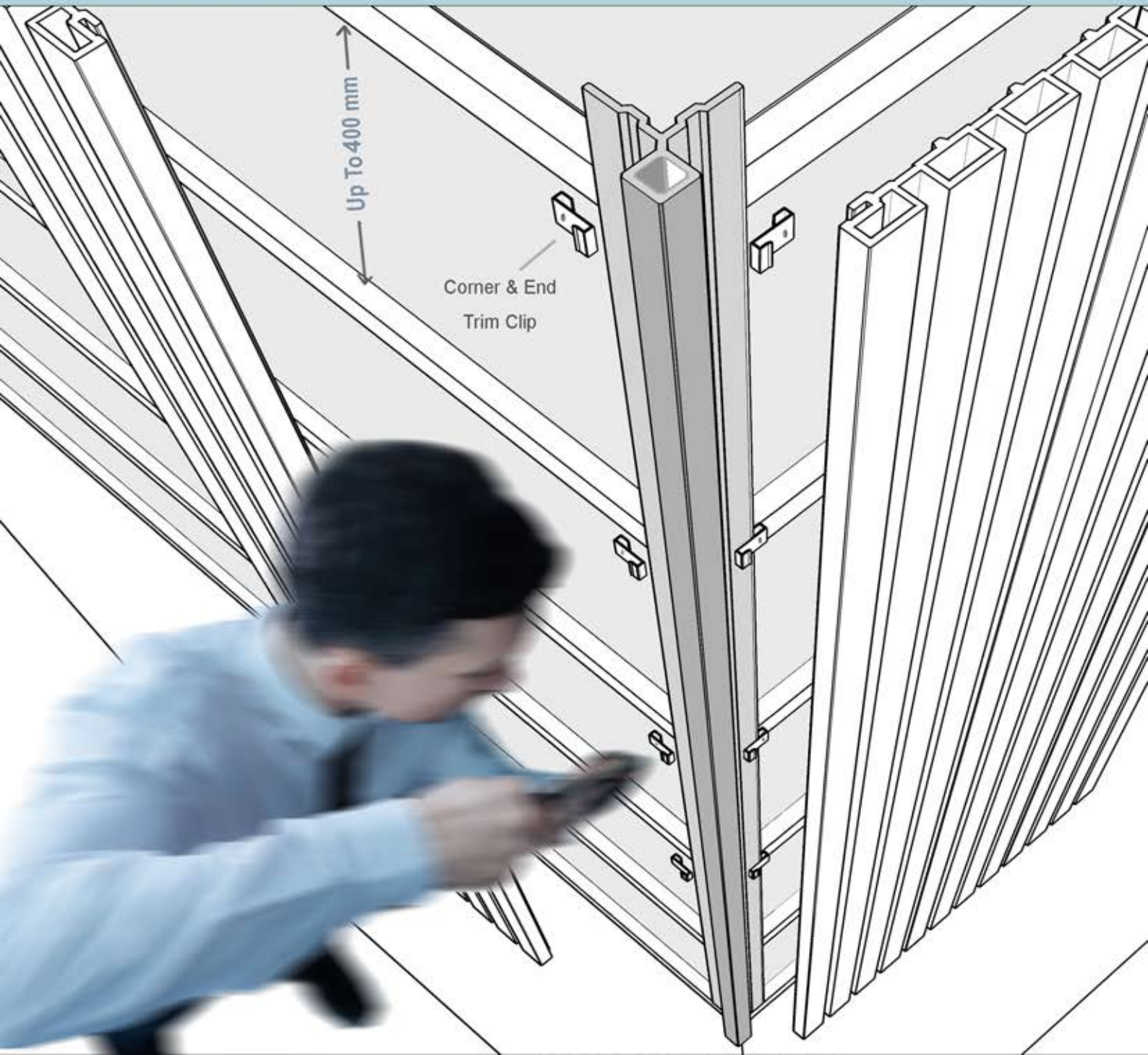



**NORT**wood

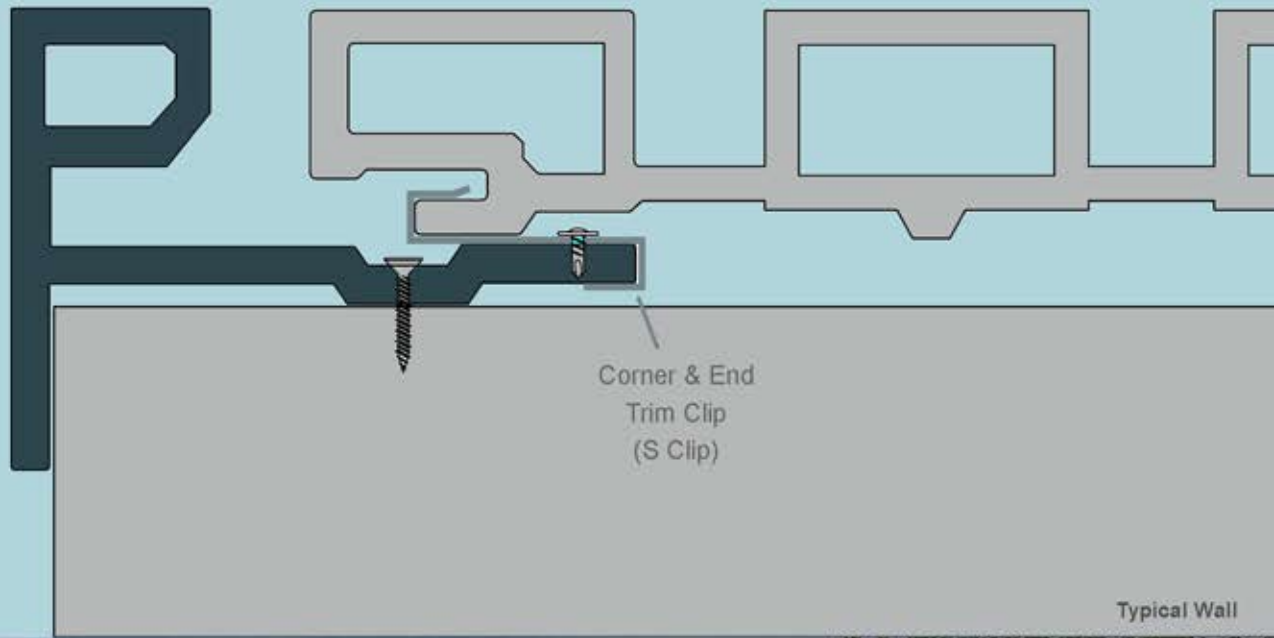

END Trim

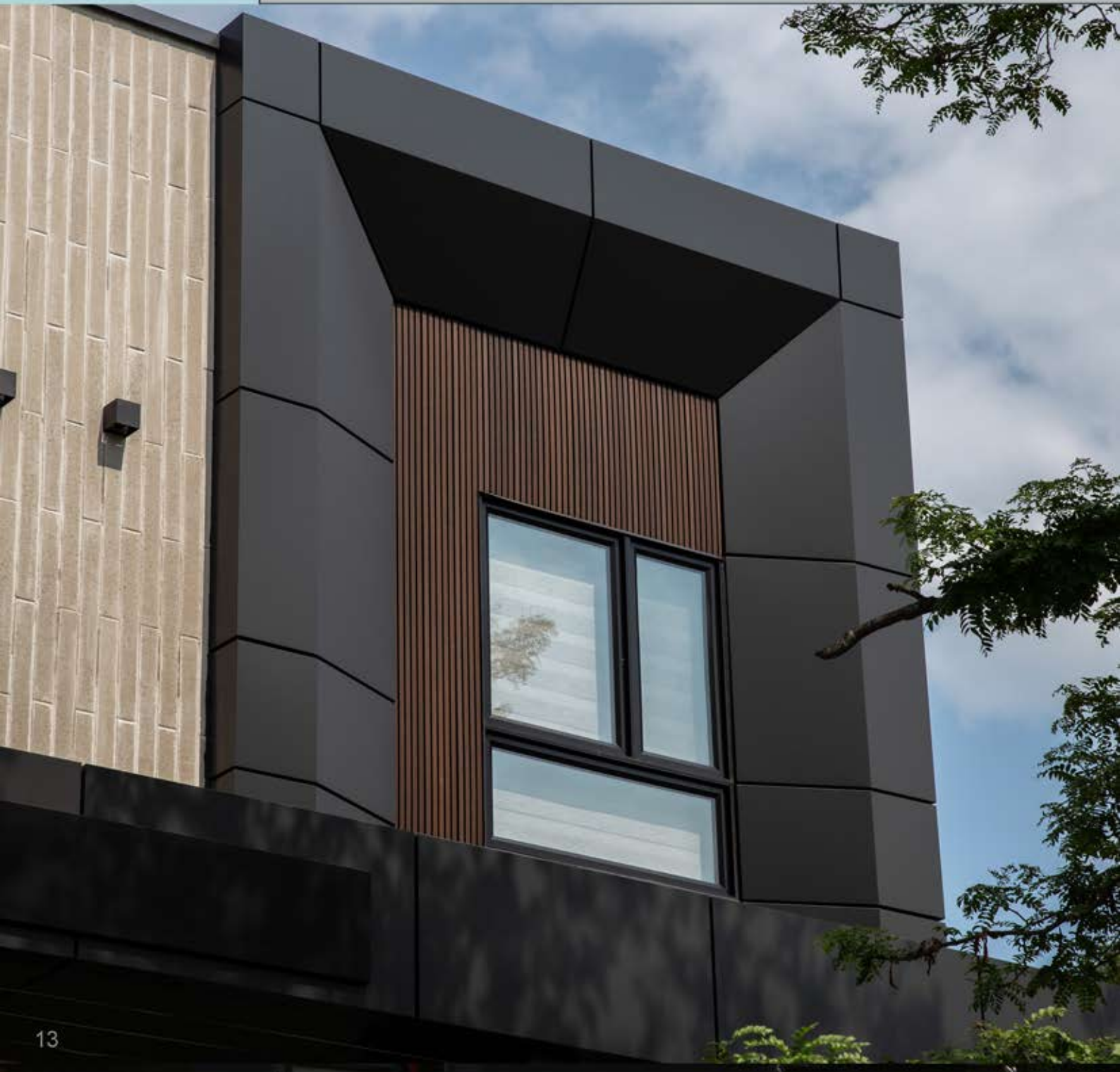

## Miter Cut Corner



To miter a corner, measure the length from the edge of the soffit or outside corner to the base of the wall. Use this measurement to mark a suitable length on a mitered panel with a marker.

Draw a line through the mark using a rafter angle square, then cut the board with a miter saw tool.

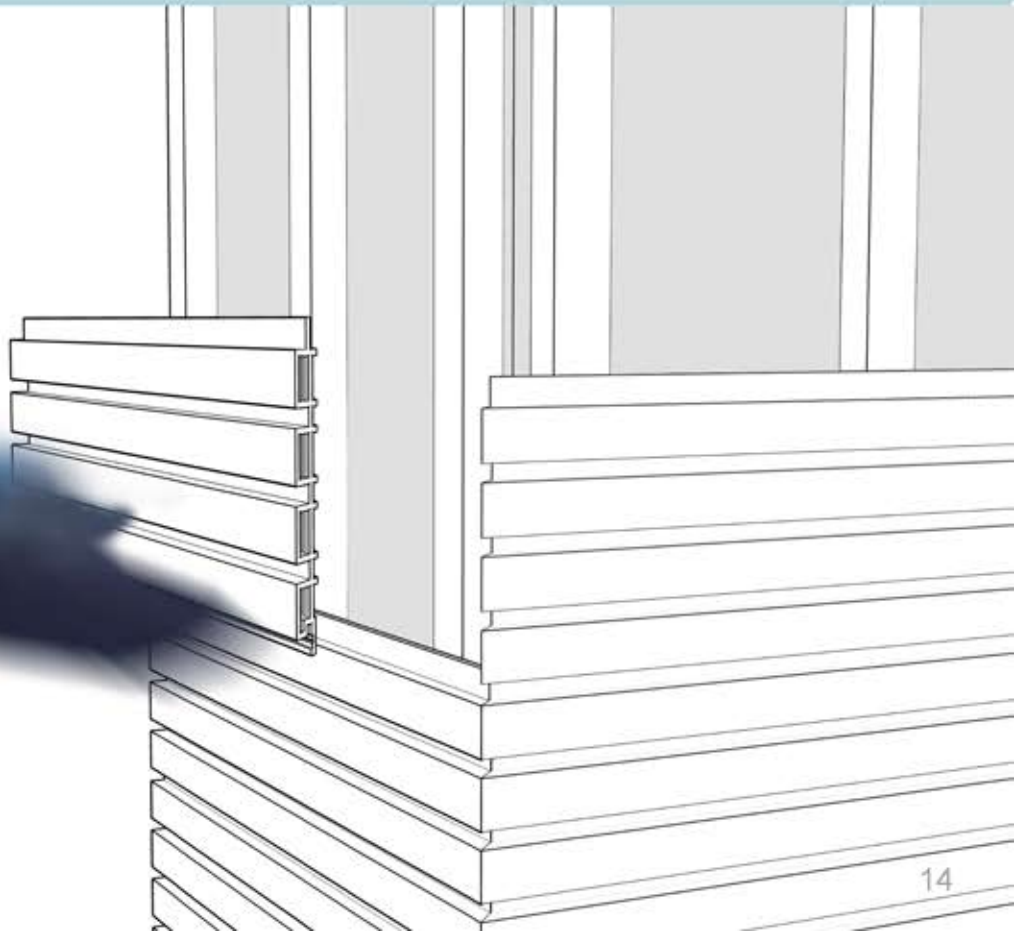



**nortWALL**  
uPVC SIDING



**nortWALL**  
uPVC Siding



### **nortWALL** Color Collection



Walnut Wood



Turner Oak



Oak Toffee



Black Wood

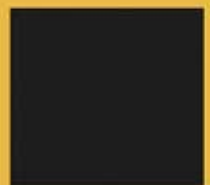

Jet Black

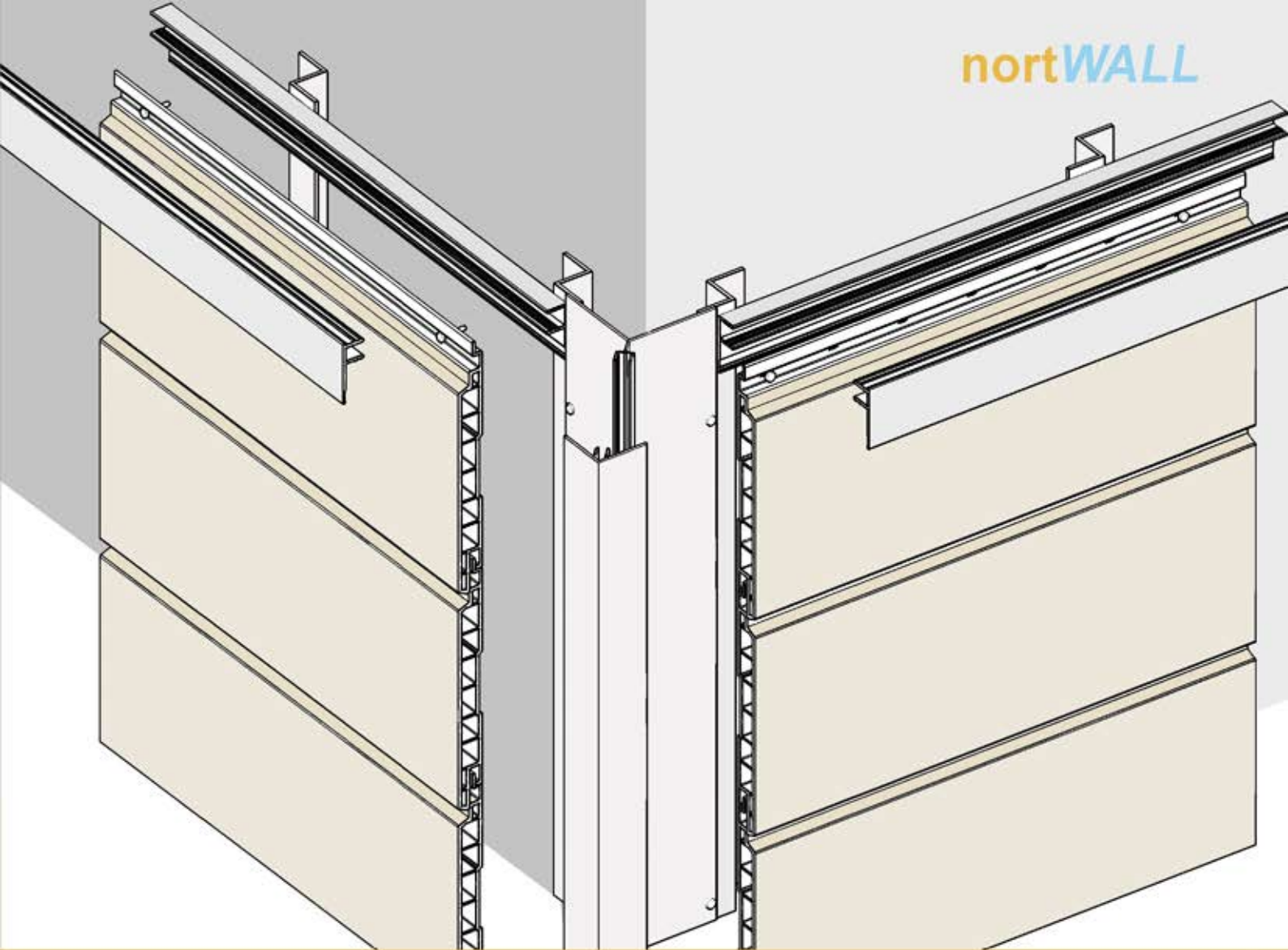

Inside & Outside Corner Trims

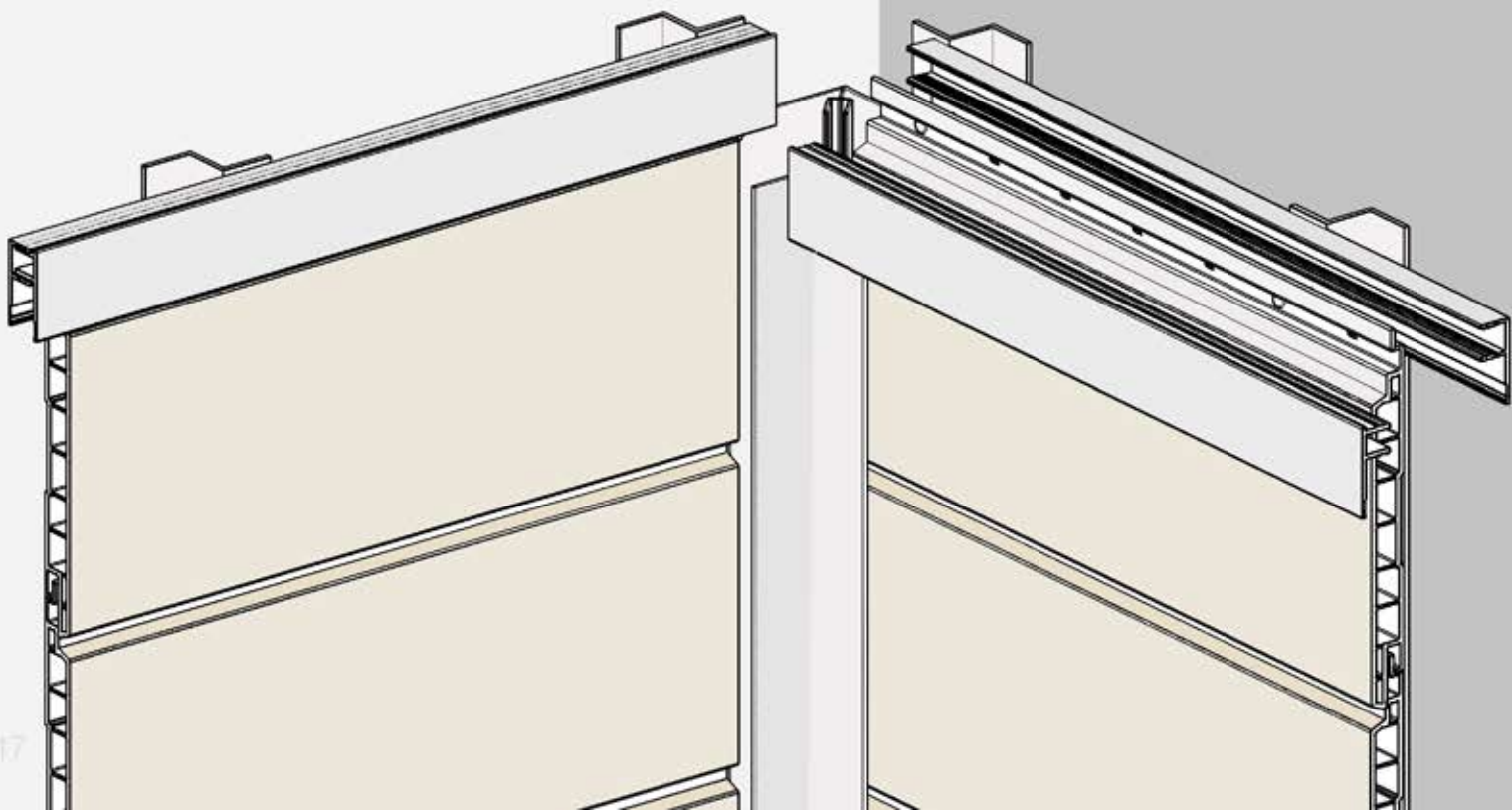

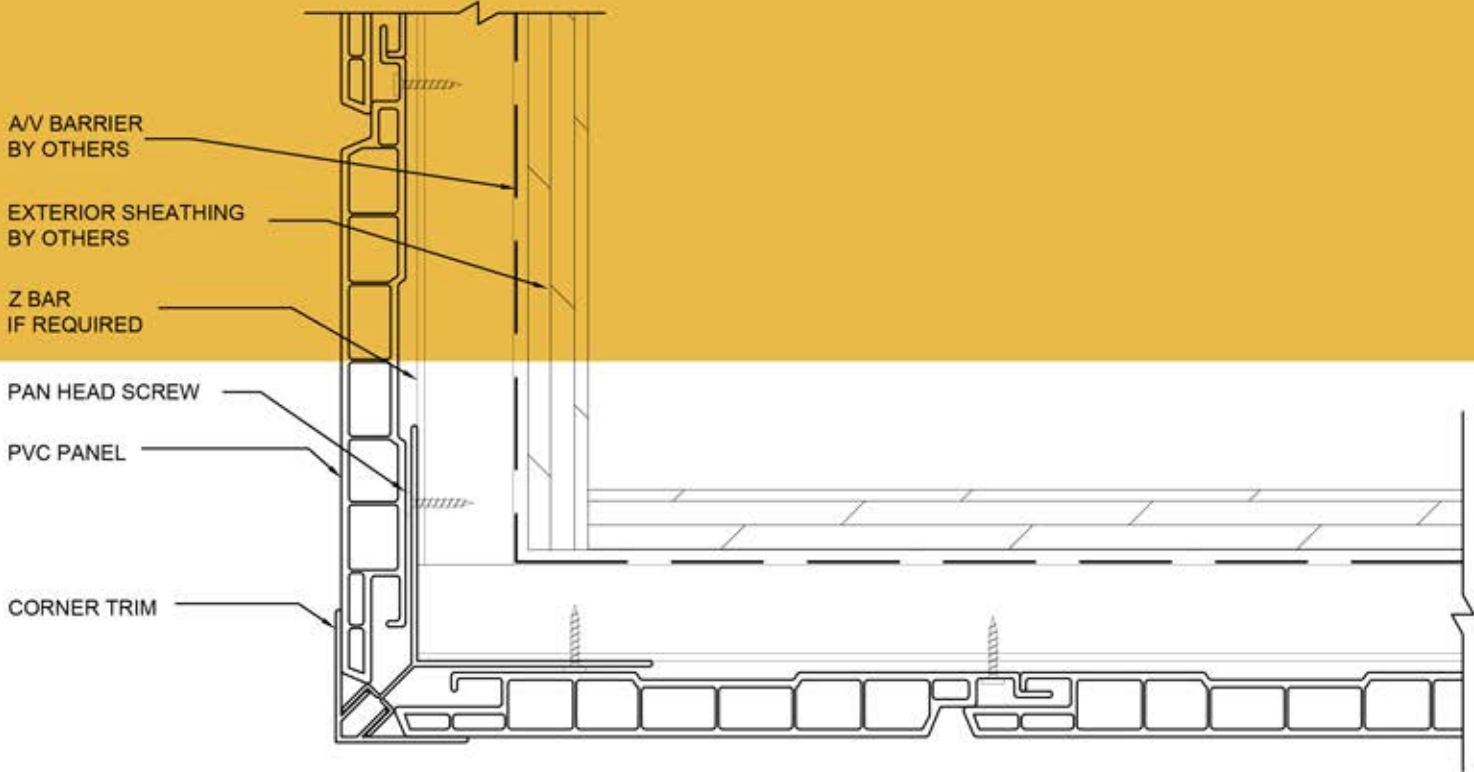

Inside & Outside corner details

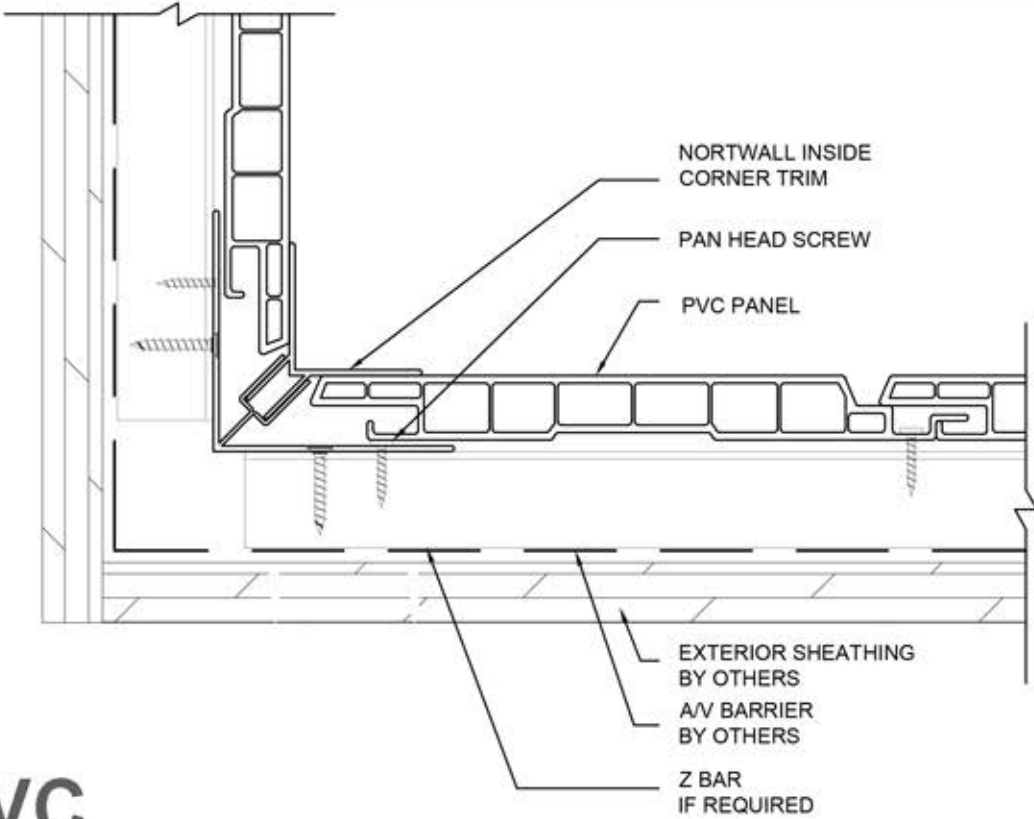

# Louver

Privacy Screen

LUV100

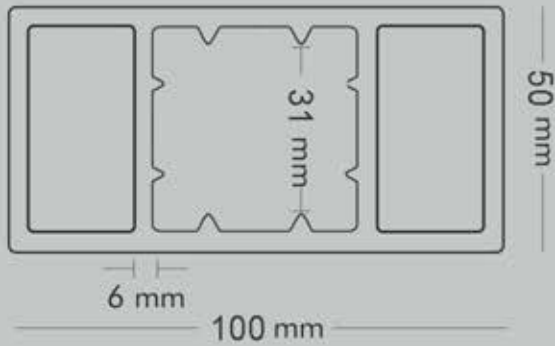

50x100mm x3600mm | 2.5 Kg/m  
(2"x 4" x 142")



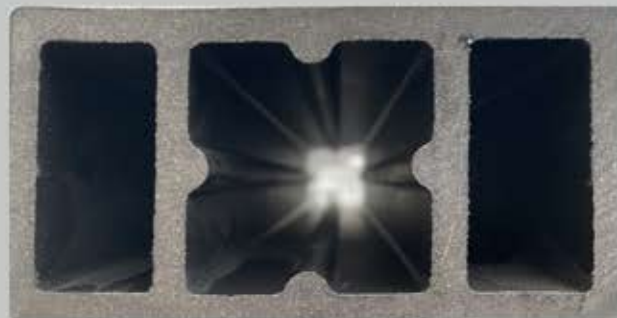

M6 Louver Screw



Louver Bracket



Louver Cap



**Aluminum Fluted Panel**

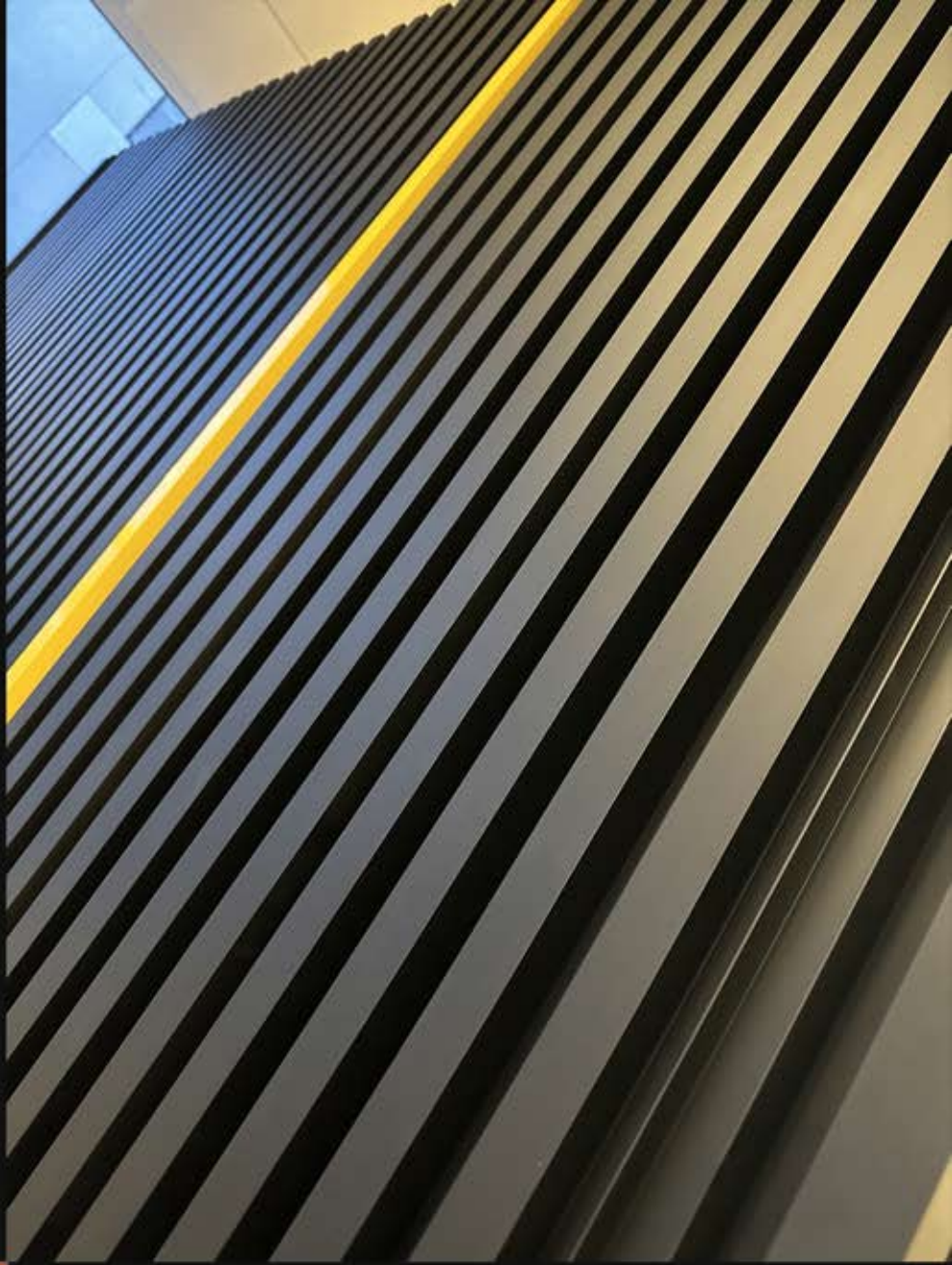

**Commercial &  
Residential**

At the intersection of aesthetics and utility, Dsoal masterfully engineers vertical aluminum facade cladding tailored for external and commercial applications.

Available in a comprehensive palette of standard colors and designed with modularity at its core, Dsoal's architectural solutions infuse an element of sophistication. With an emphasis on accentuated features, these solutions merge additional details with such finesse that they enhance the overall facade.

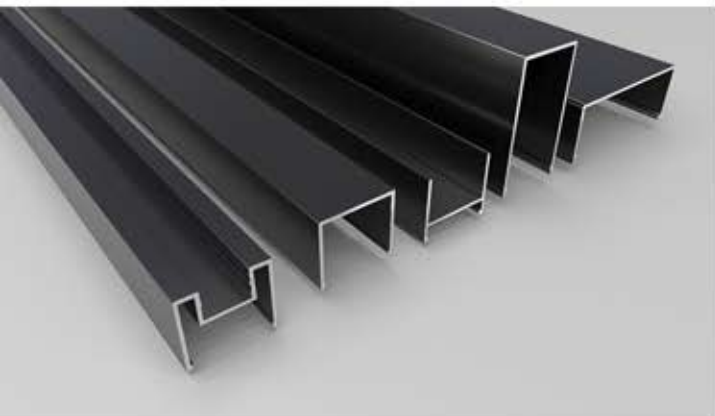

### Why You Should Choose Dsoal Panels?

**Non-Combustibility:** Safety is paramount. Dsoal Panels are non-combustible, ensuring compliance with safety standards and offering peace of mind in terms of fire resistance.

**Adaptable Cap System:** The innovative Cap System empowers you to easily alter the combination of cap shapes and colors, enabling customization that aligns perfectly with your design vision.

**Versatile Application:** Whether it's in commercial spaces like hotels and shopping malls or residential areas, Dsoal Panels seamlessly integrate as decorative features, enhancing the ambiance and elevating the overall look and feel.

**Cost-Efficiency:** Dsoal Panels provide a cost-effective solution for achieving a high-end, customized appearance. They allow you to transform interiors and exteriors without breaking the bank.

**Aesthetic Excellence:** Dsoal Panels are crafted with an eye for detail, ensuring a stunning visual appeal. Their unique fluted design adds a touch of elegance and sophistication to any space.

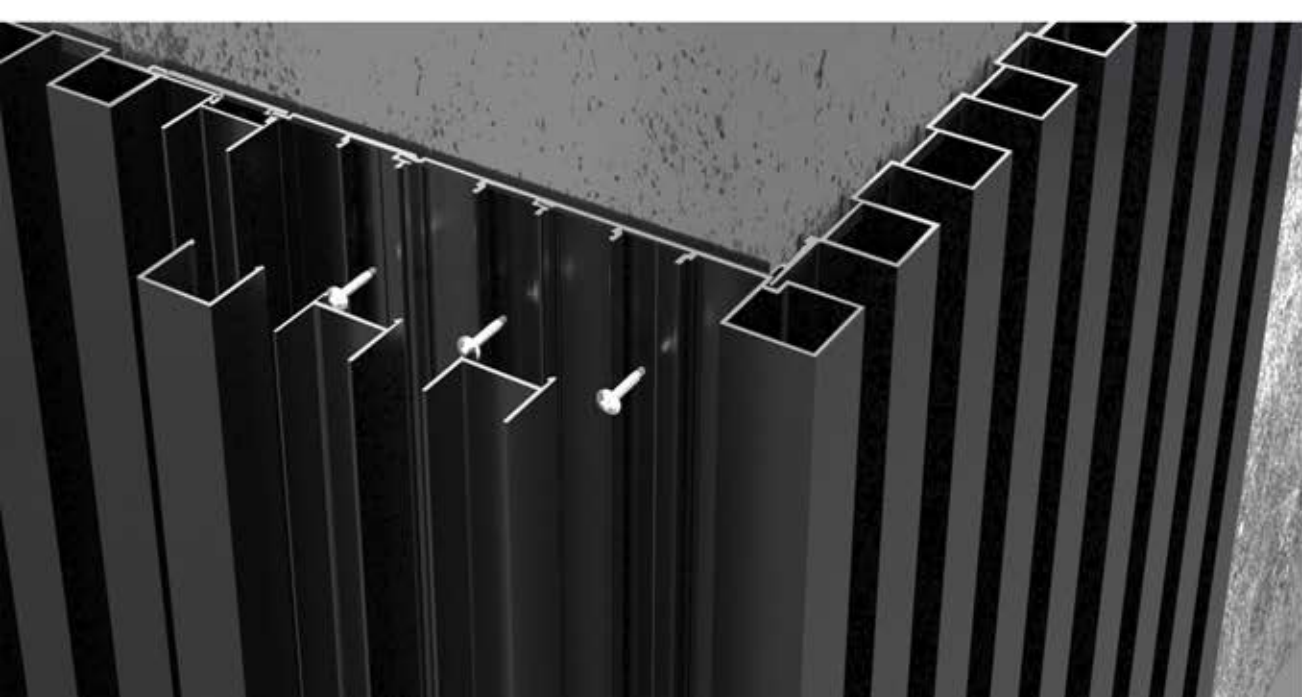
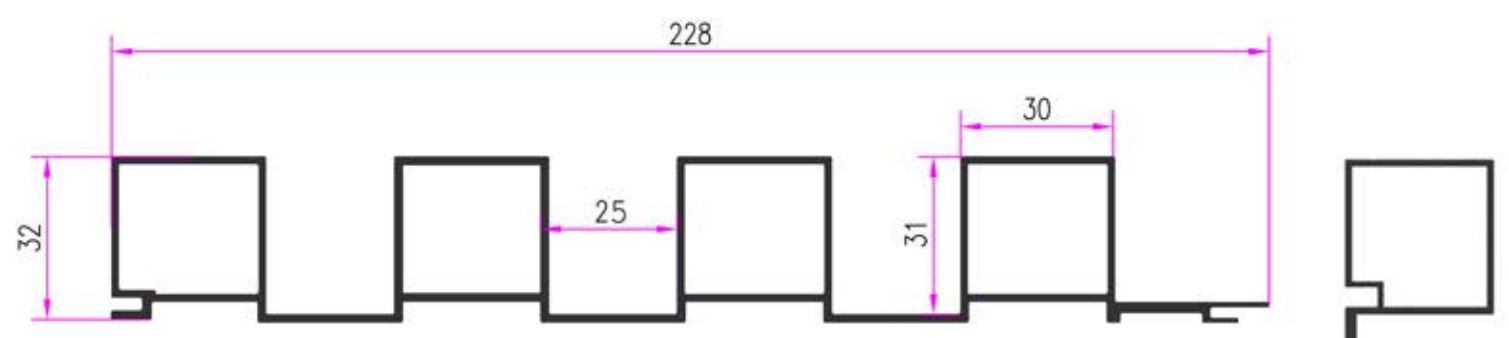



Wide Cap

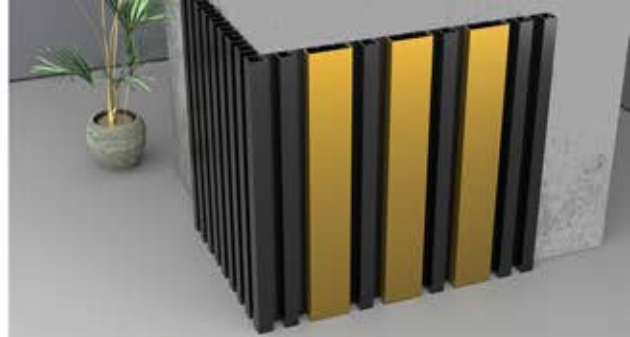

Light Chanal



Blade Cap



Standard Cap



Extended Cap





**STUNNING.**

**BOLD.**

**SLEEK.**



**D**SOAL

Dsoal Color Collection

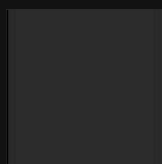
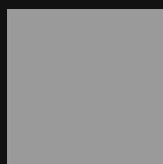
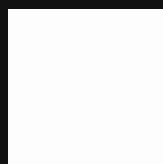
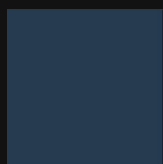
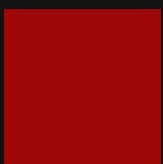

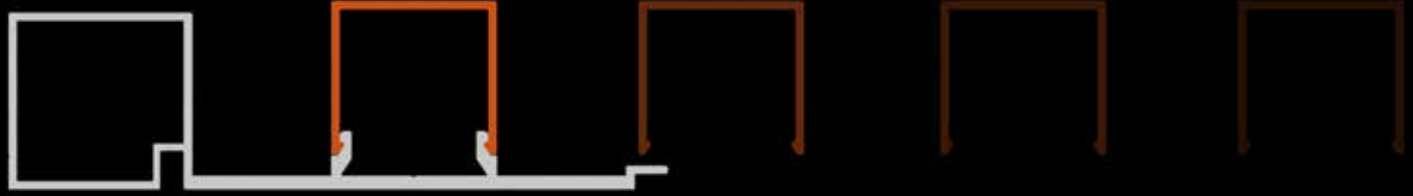



**NORT**wood

**DSOAL**

**CANADA**  
133 Romina Drive  
Concord, L4K4Z9  
ON, Canada  
Tel: +1 647.804.4060

**USA**  
375 N French Rd  
Amherst, Unit 106  
NY, 14228  
Tel: +1 716.808.0380

Tech Support: [647.978.5013](tel:647.978.5013)  
Toll-Free: [+1.888.308.8898](tel:+1.888.308.8898)  
Email: [info@nortwood.com](mailto:info@nortwood.com)  
[www.NORTwood.com](http://www.NORTwood.com)