

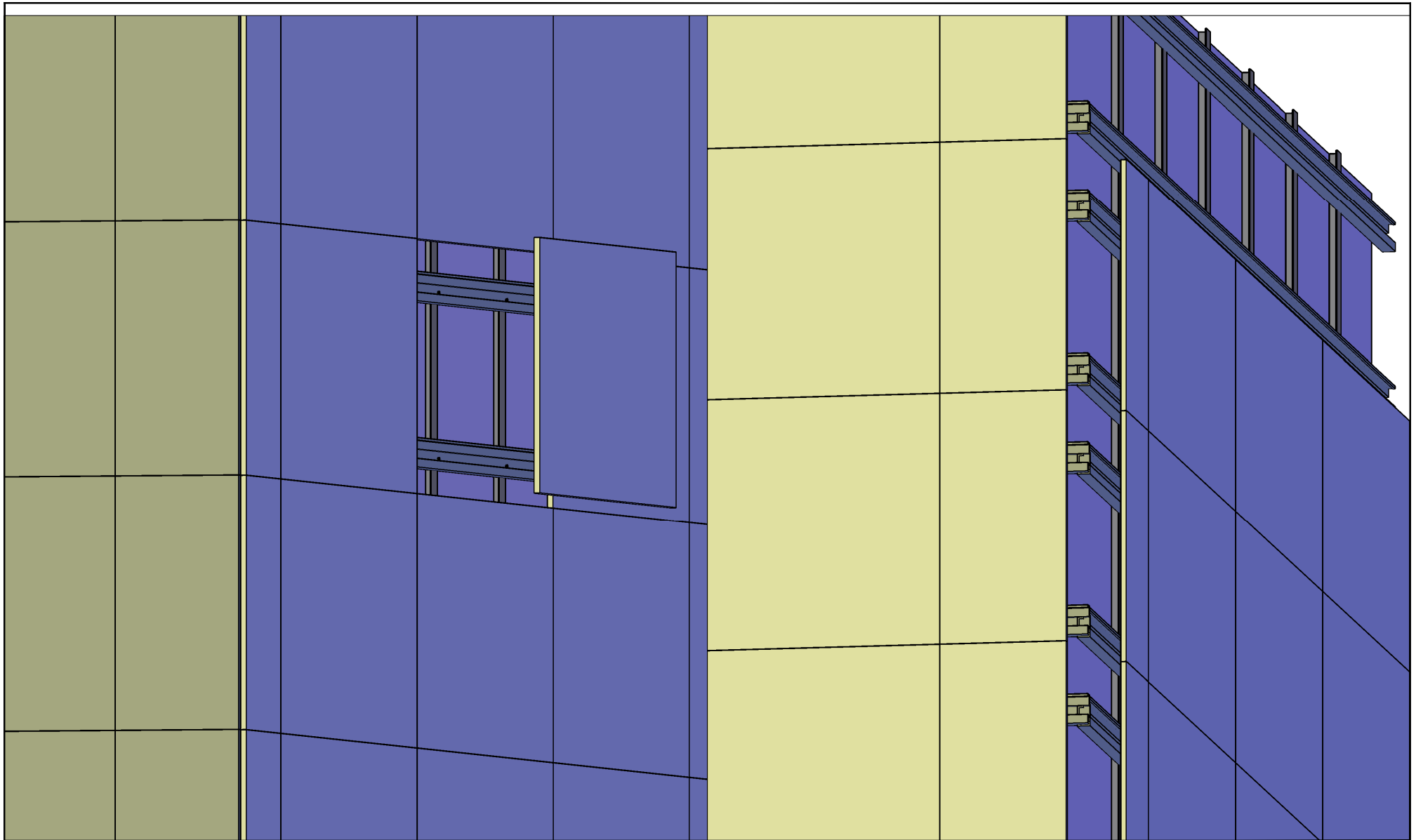



SITE: XXX	XX DRAWING NO.		XX PROJECT NO.	MM,DD,YY DATE.	 <p>133 Romina Dr, Concord ON L4K 4Z9 Phone: 1(888)308-8898 email: info@nortem.ca www.nortem.ca</p>
TITLE: CONCRETE DETAIL	1:2 SCALE AT A4.	AS DRAWN.	XX CHECKED.	00 REVISION.	



SITE: XXX	XX DRAWING NO.		XX PROJECT NO.	MM,DD,YY DATE.	 <p>133 Romina Dr, Concord ON L4K 4Z9 Phone: 1(888)308-8898 email: info@nortem.ca www.nortem.ca</p>
TITLE: CONCRETE DETAIL	2:1 SCALE AT A4.	AS DRAWN.	XX CHECKED.	00 REVISION.	

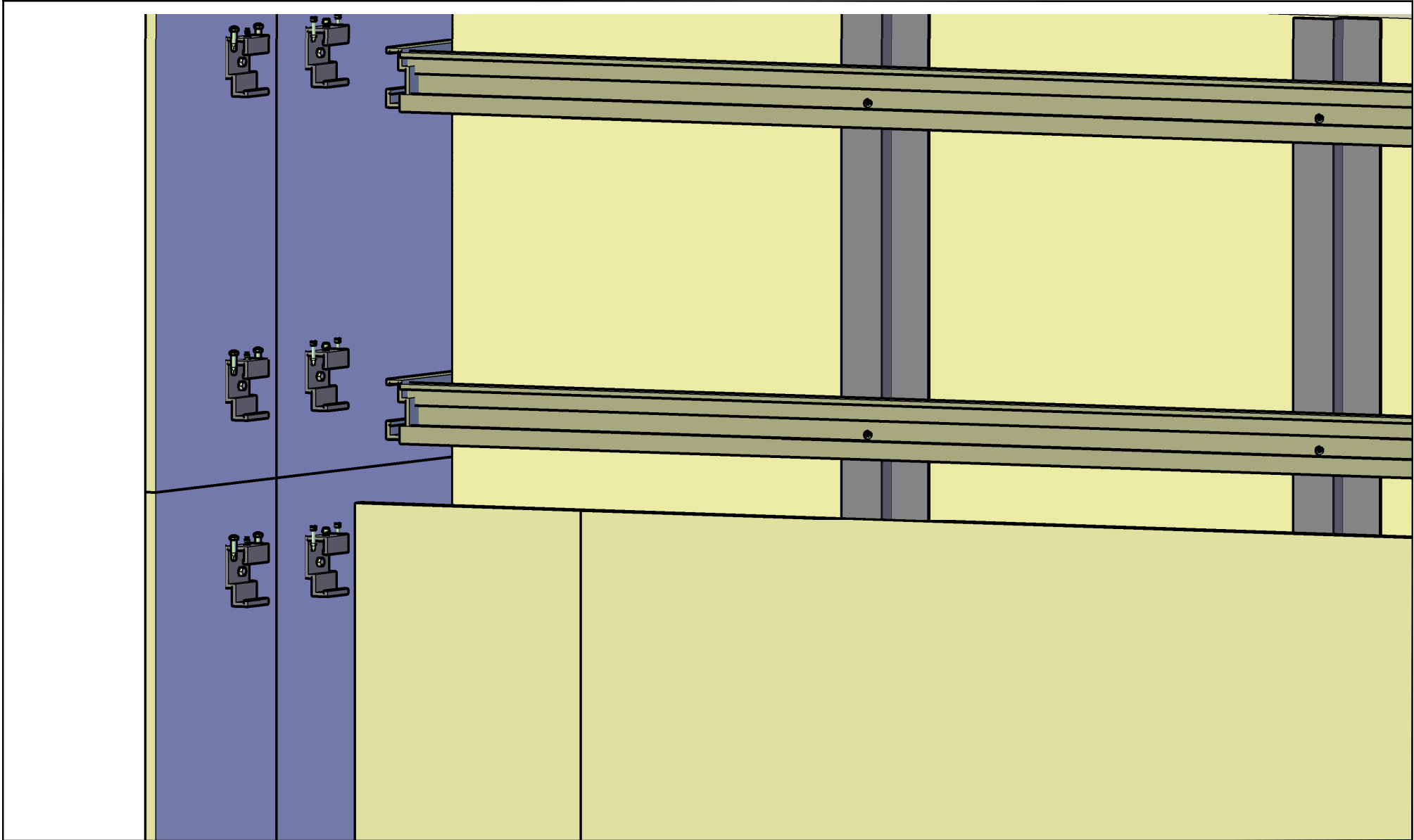

SITE: XXX	XX DRAWING NO.		XX PROJECT NO.	MM,DD,YY DATE.	 133 Romina Dr, Concord ON L4K 4Z9 Phone: 1(888)308-8898 email: info@nortem.ca www.nortem.ca
TITLE: CONCRETE DETAIL	4:1 SCALE AT A4.	AS DRAWN.	XX CHECKED.	00 REVISION.	

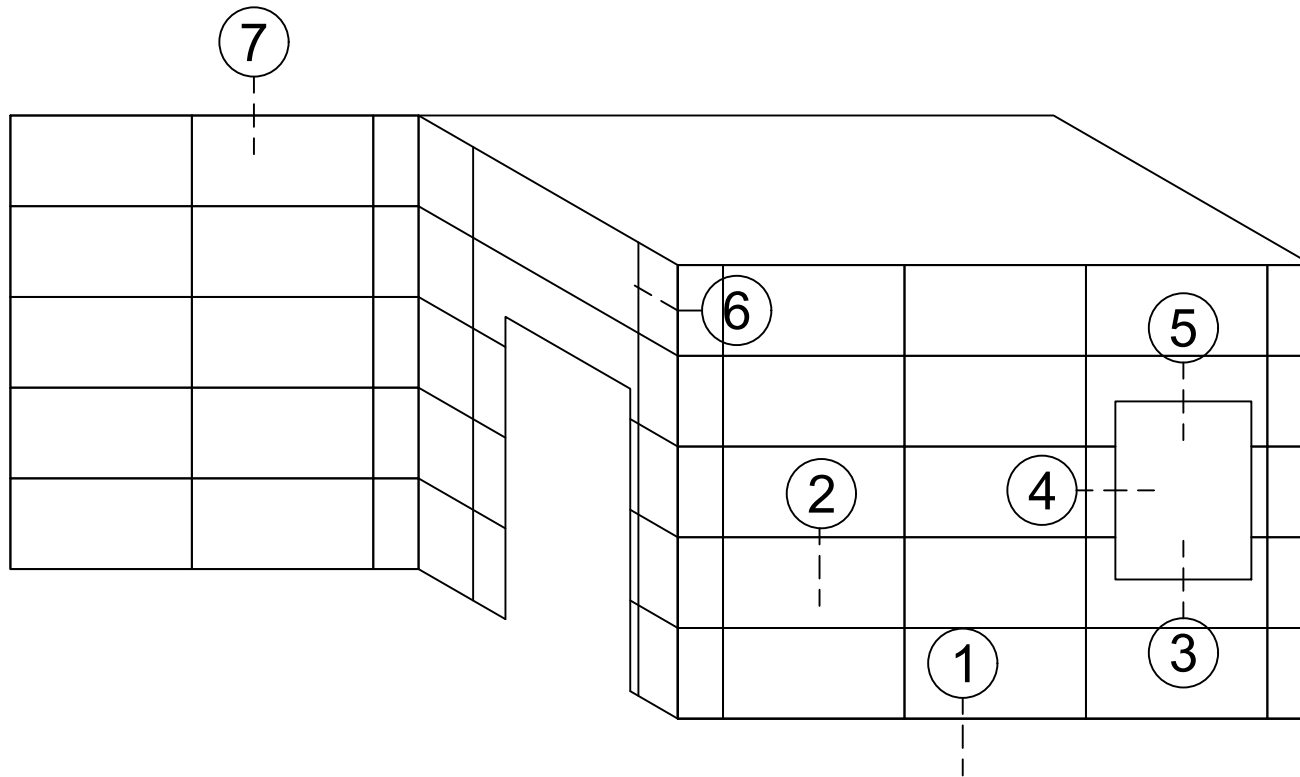

SITE: XXX	XX DRAWING NO.		XX PROJECT NO.	MM,DD,YY DATE.	 133 Romina Dr, Concord ON L4K 4Z9 Phone: 1(888)308-8898 email: info@nortem.ca www.nortem.ca
TITLE: CONCRETE DETAIL	1:2 SCALE AT A4.	AS DRAWN.	XX CHECKED.	00 REVISION.	

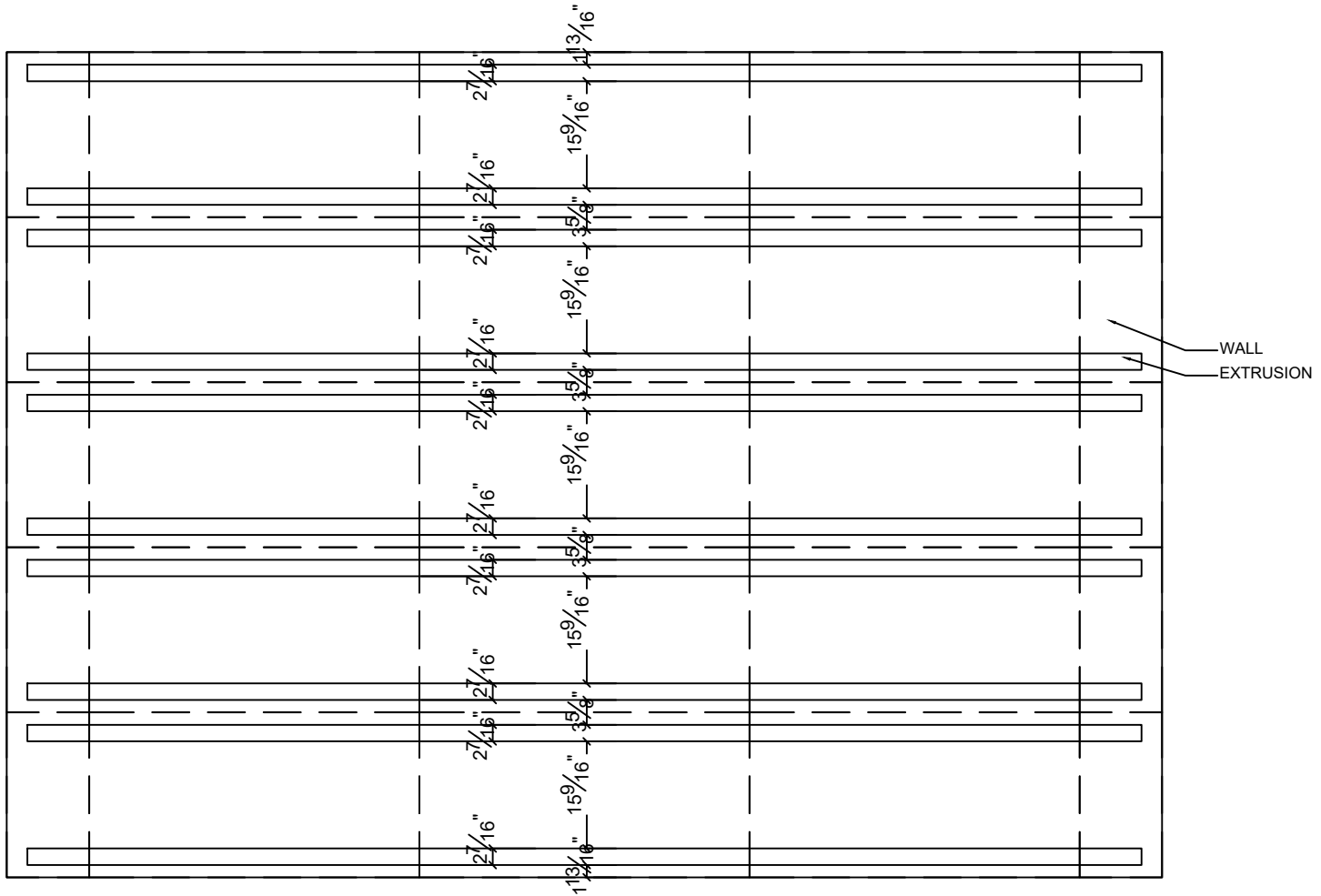

SITE: XXX	XX DRAWING NO.		XX PROJECT NO.	MM,DD,YY DATE.	 <p>133 Romina Dr, Concord ON L4K 4Z9 Phone: 1(888)308-8898 email: info@nortem.ca www.nortem.ca</p>
TITLE: CONCRETE DETAIL (WALL)	1:1 SCALE AT A4.	AS DRAWN.	XX CHECKED.	00 REVISION.	

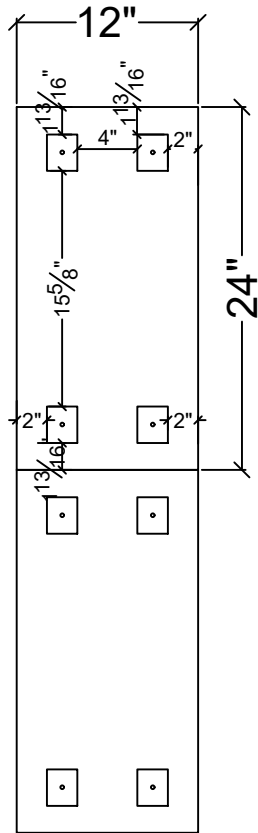

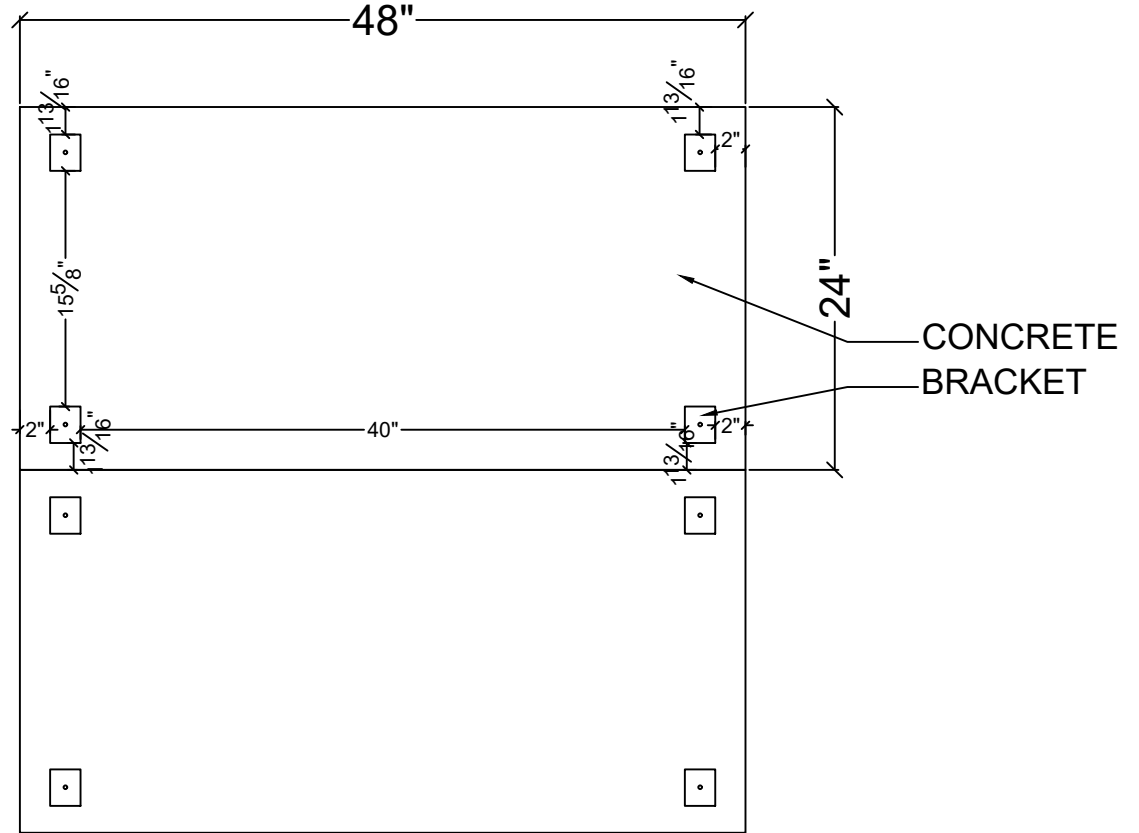

**CORNER
CONCRETE PANEL**



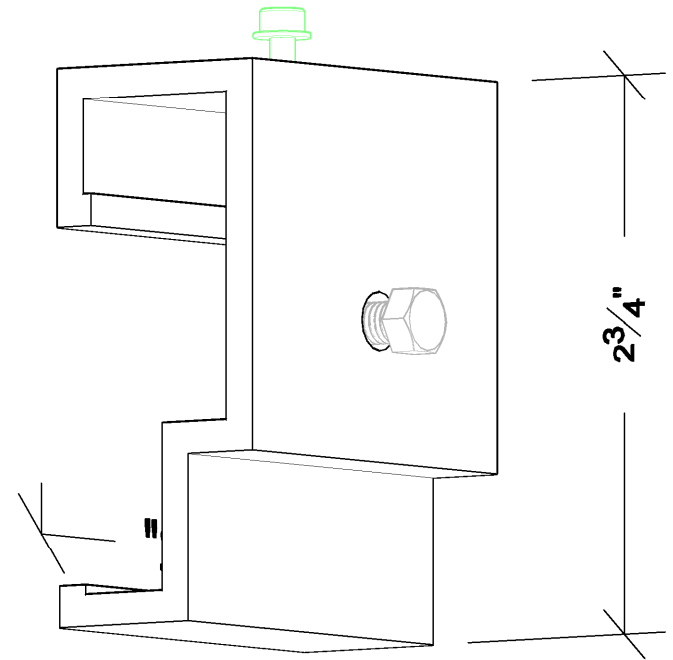
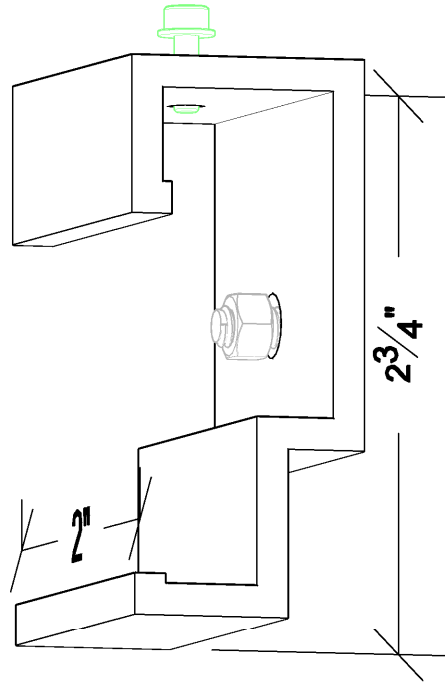

**TYPICAL
CONCRETE PANEL**

SITE: XXX	XX DRAWING NO.	XX PROJECT NO.	MM,DD,YY DATE.		133 Romina Dr, Concord ON L4K 4Z9 Phone: 1(888)308-8898 email: info@nortem.ca www.nortem.ca
TITLE: CONCRETE DETAIL (PANEL)	2:1 SCALE AT A4.	AS DRAWN.	XX CHECKED. 00 REVISION.		

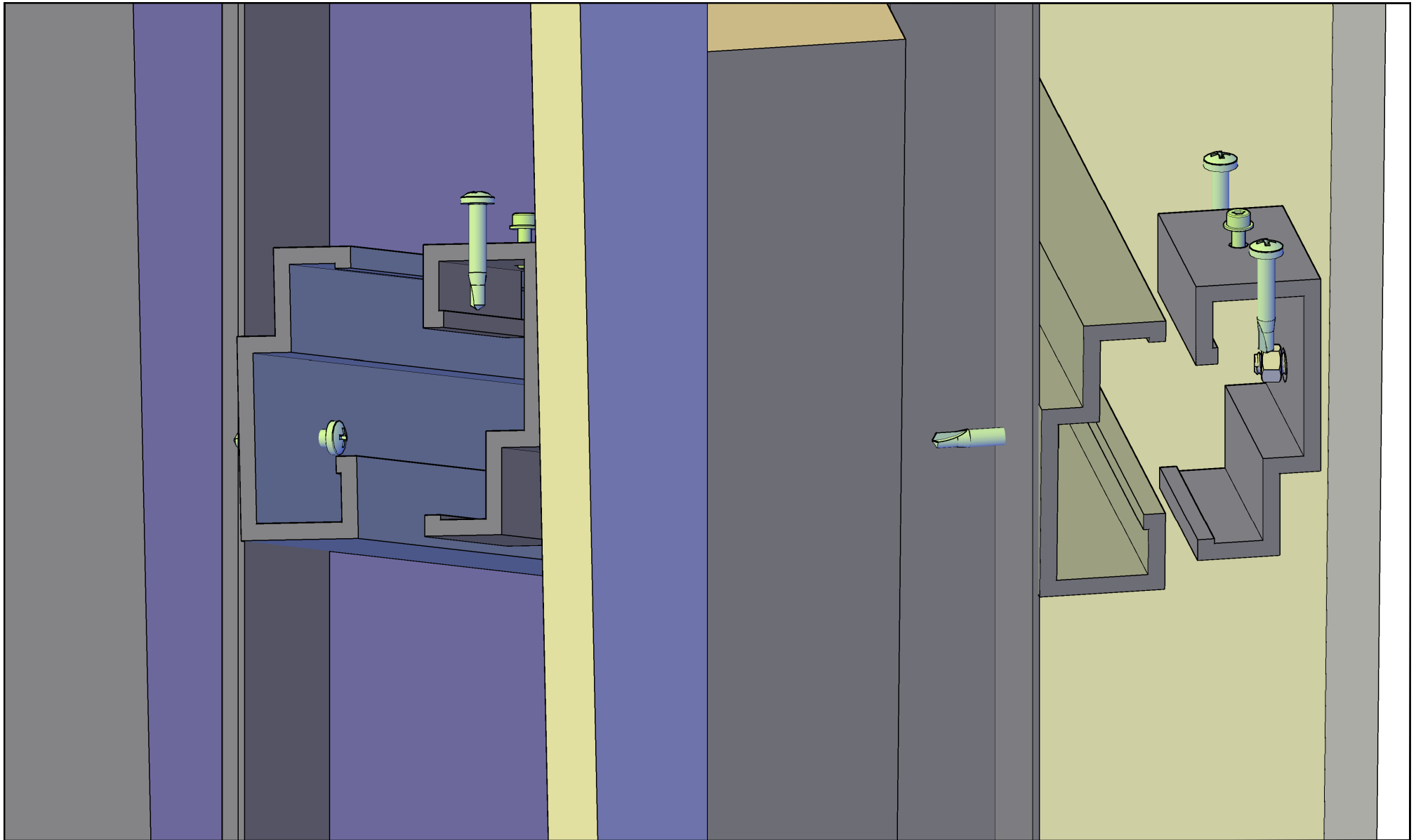

SITE: XXX	XX DRAWING NO.	XX PROJECT NO.	MM,DD,YY DATE.		133 Romina Dr, Concord ON L4K 4Z9 Phone: 1(888)308-8898 email: info@nortem.ca www.nortem.ca
TITLE: CONCRETE DETAIL (BRACKET)	27:1 SCALE AT A4.	AS DRAWN.	XX CHECKED.		



SITE: XXX	XX DRAWING NO.		XX PROJECT NO.	MM,DD,YY DATE.	 <p>133 Romina Dr, Concord ON L4K 4Z9 Phone: 1(888)308-8898 email: info@nortem.ca www.nortem.ca</p>
TITLE: CONCRETE DETAIL	20:1 SCALE AT A4.	AS DRAWN.	XX CHECKED.	00 REVISION.	

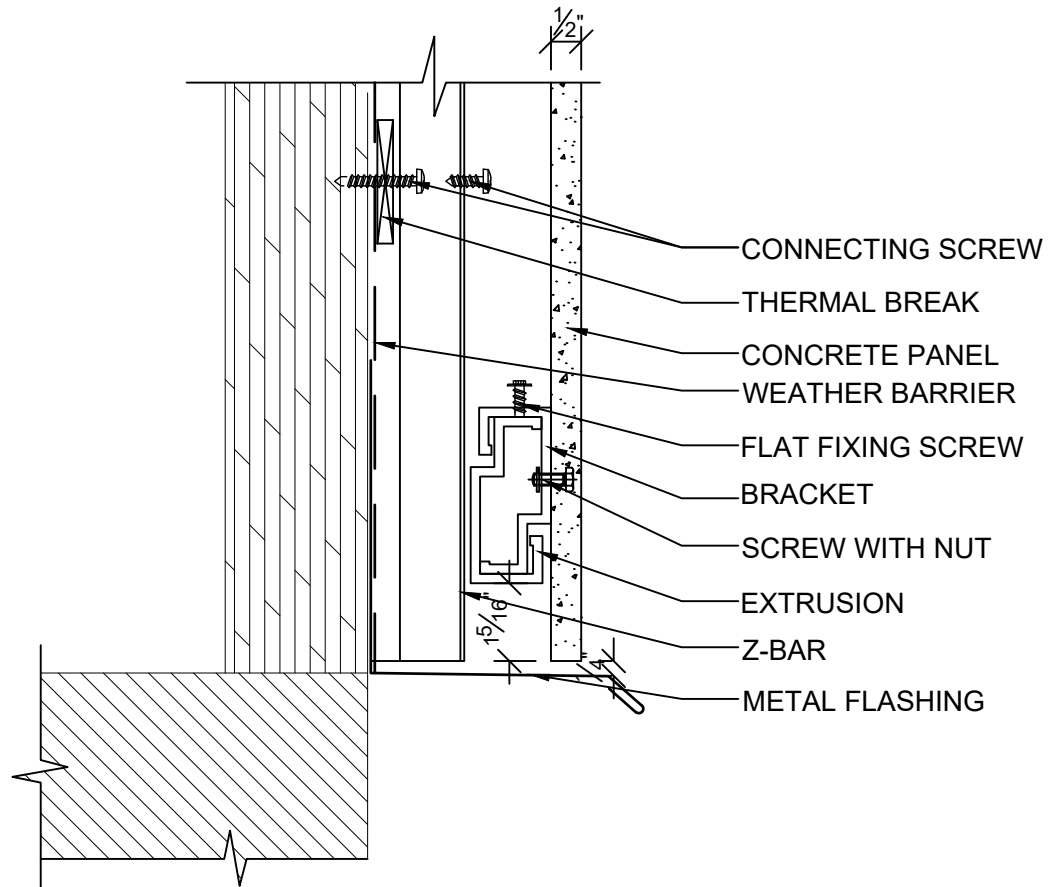

CONCRETE END Details 1

SITE: XXX	DRAWING NO. XX	PROJECT NO. XX	DATE. MM,DD,YY		133 Romina Dr, Concord ON L4K 4Z9 Phone: 1(888)308-8898 email: info@nortem.ca www.nortem.ca
TITLE: CONCRETE DETAIL 1	SCALE AT A4. 8:1	DRAWN. AS	CHECKED. XX		

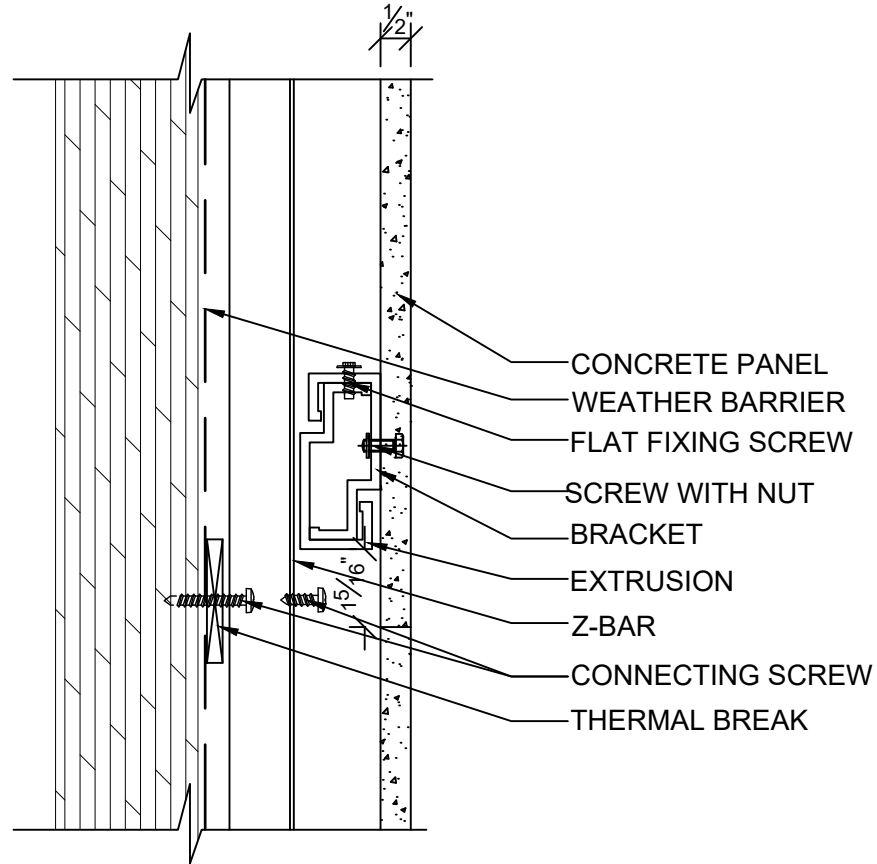

CONCRETE MIDDLE Details 2

SITE: XXX	XX DRAWING NO.	XX PROJECT NO.	MM,DD,YY DATE.		133 Romina Dr, Concord ON L4K 4Z9 Phone: 1(888)308-8898 email: info@nortem.ca www.nortem.ca
TITLE: CONCRETE DETAIL 2	8:1 SCALE AT A4.	AS DRAWN.	XX CHECKED.		

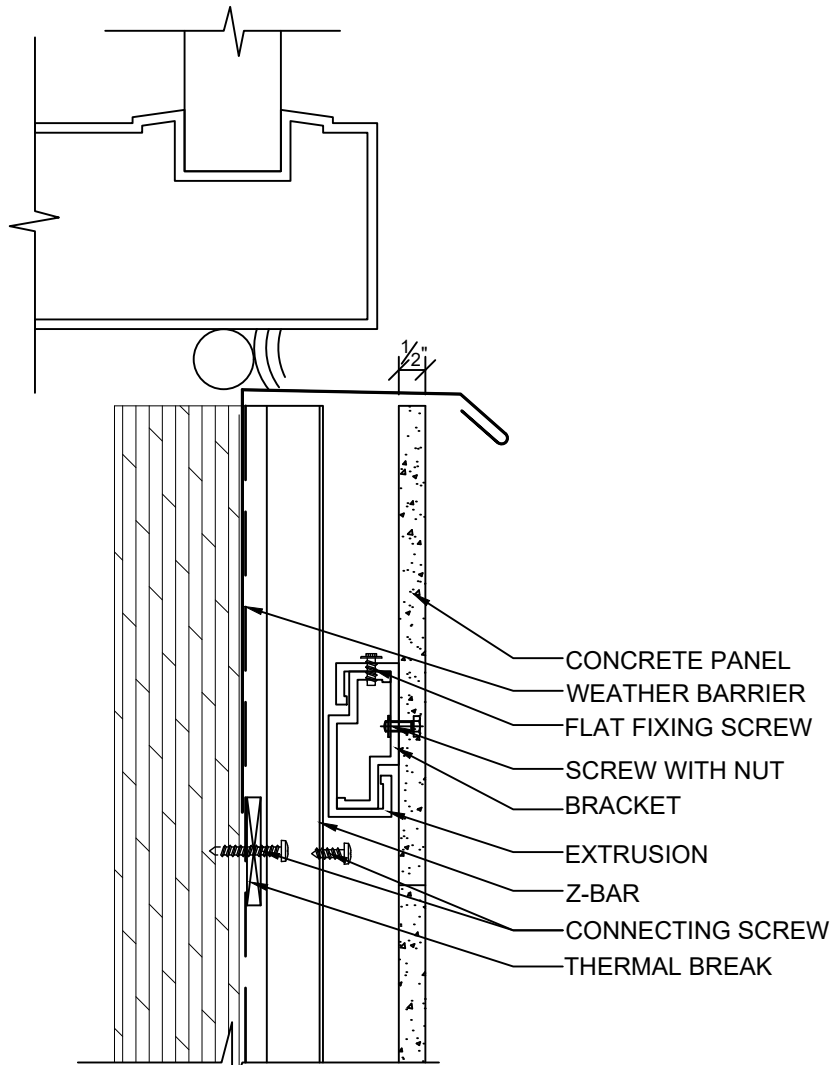

CONCRETE WINDOW
Details 3

SITE: XXX	XX DRAWING NO.		XX PROJECT NO.	MM,DD,YY DATE.	 <p>133 Romina Dr, Concord ON L4K 4Z9 Phone: 1(888)308-8898 email: info@nortem.ca www.nortem.ca</p>
TITLE: CONCRETE DETAIL 3	7:1 SCALE AT A4.	AS DRAWN.	XX CHECKED.	00 REVISION.	

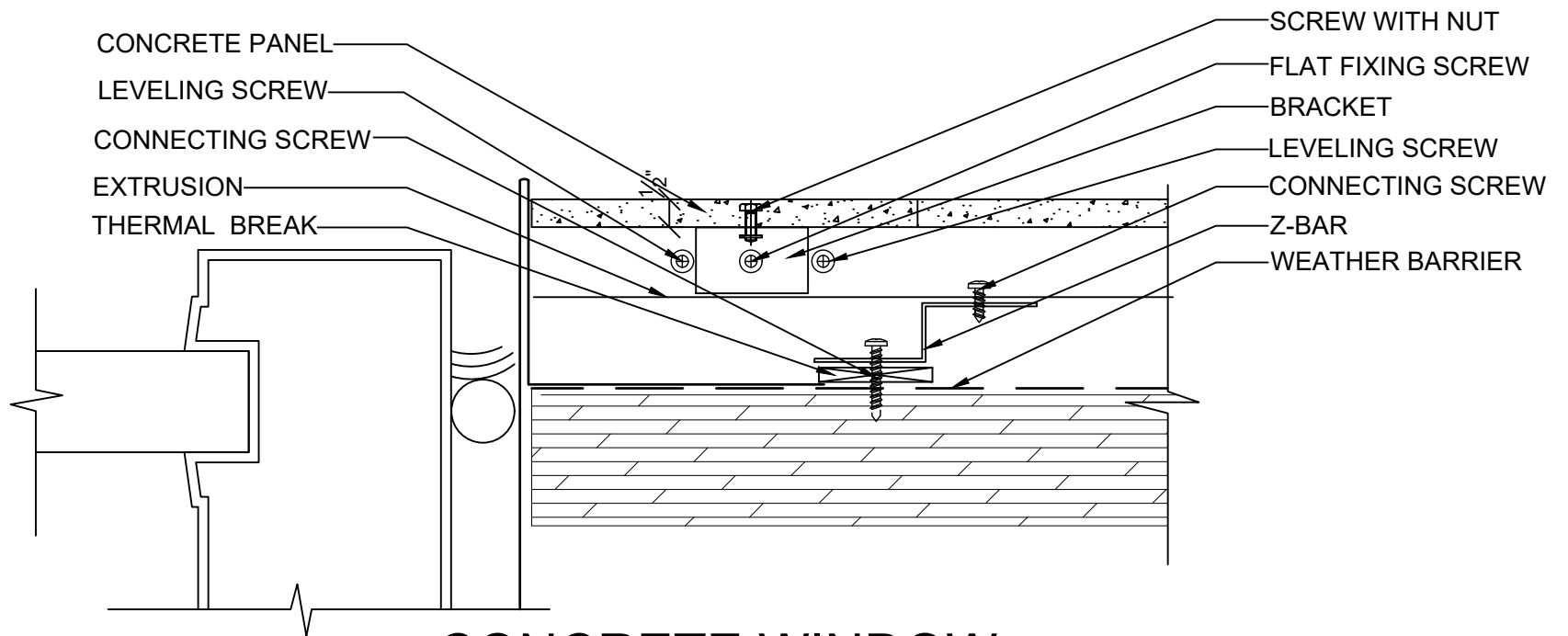

CONCRETE WINDOW Details 4

SITE: XXX	DRAWING NO. XX	PROJECT NO. XX	DATE. MM,DD,YY		133 Romina Dr, Concord ON L4K 4Z9 Phone: 1(888)308-8898 email: info@nortem.ca www.nortem.ca
TITLE: CONCRETE DETAIL 4	SCALE AT A4. 8:1	DRAWN. AS	CHECKED. XX		

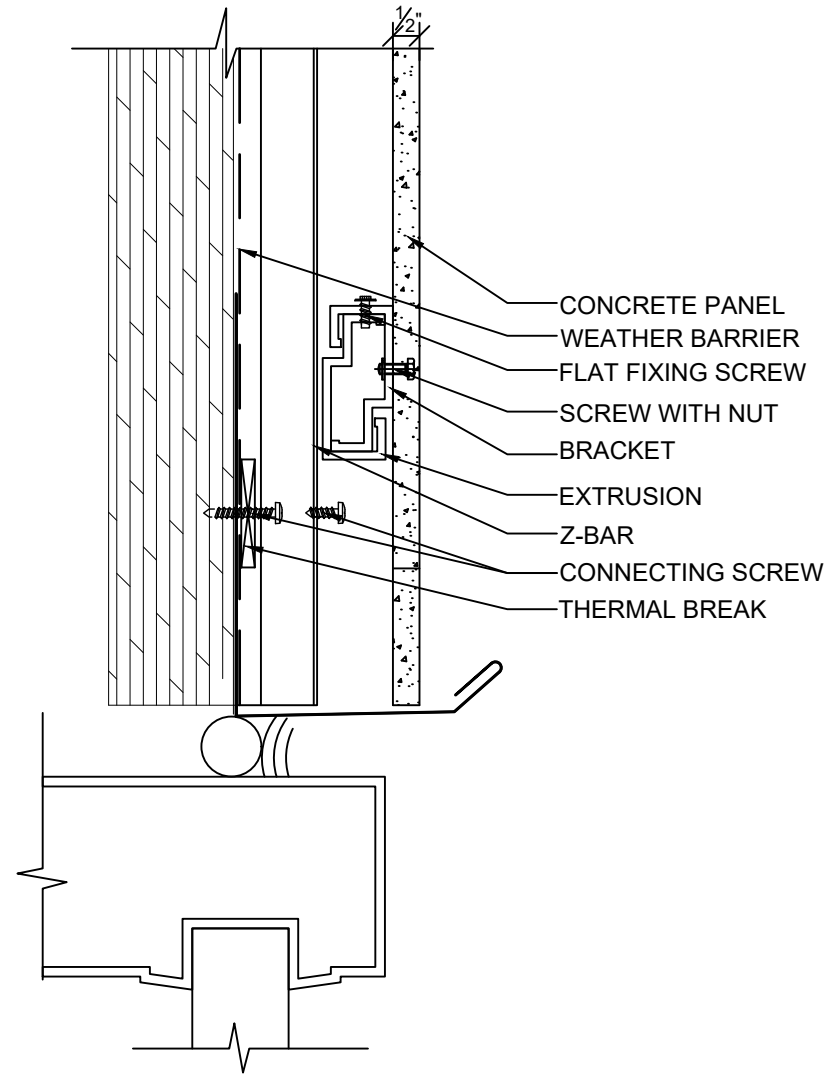

- CONCRETE PANEL
- WEATHER BARRIER
- FLAT FIXING SCREW
- SCREW WITH NUT
- BRACKET
- EXTRUSION
- Z-BAR
- CONNECTING SCREW
- THERMAL BREAK

CONCRETE WINDOW
Details 5

SITE: <div style="text-align: center; font-size: 1.2em;">XXX</div>	XX <small>DRAWING NO.</small>	XX <small>PROJECT NO.</small>	MM,DD,YY <small>DATE.</small>	<div style="font-size: 2em; font-weight: bold; letter-spacing: 0.5em;">K INN</div>	133 Romina Dr, Concord ON L4K 4Z9 Phone: 1(888)308-8898 email: info@nortem.ca www.nortem.ca
TITLE: <div style="text-align: center; font-size: 1.2em;">CONCRETE DETAIL 5</div>	7:1 <small>SCALE AT A4.</small>	AS <small>DRAWN.</small>	XX <small>CHECKED.</small>		

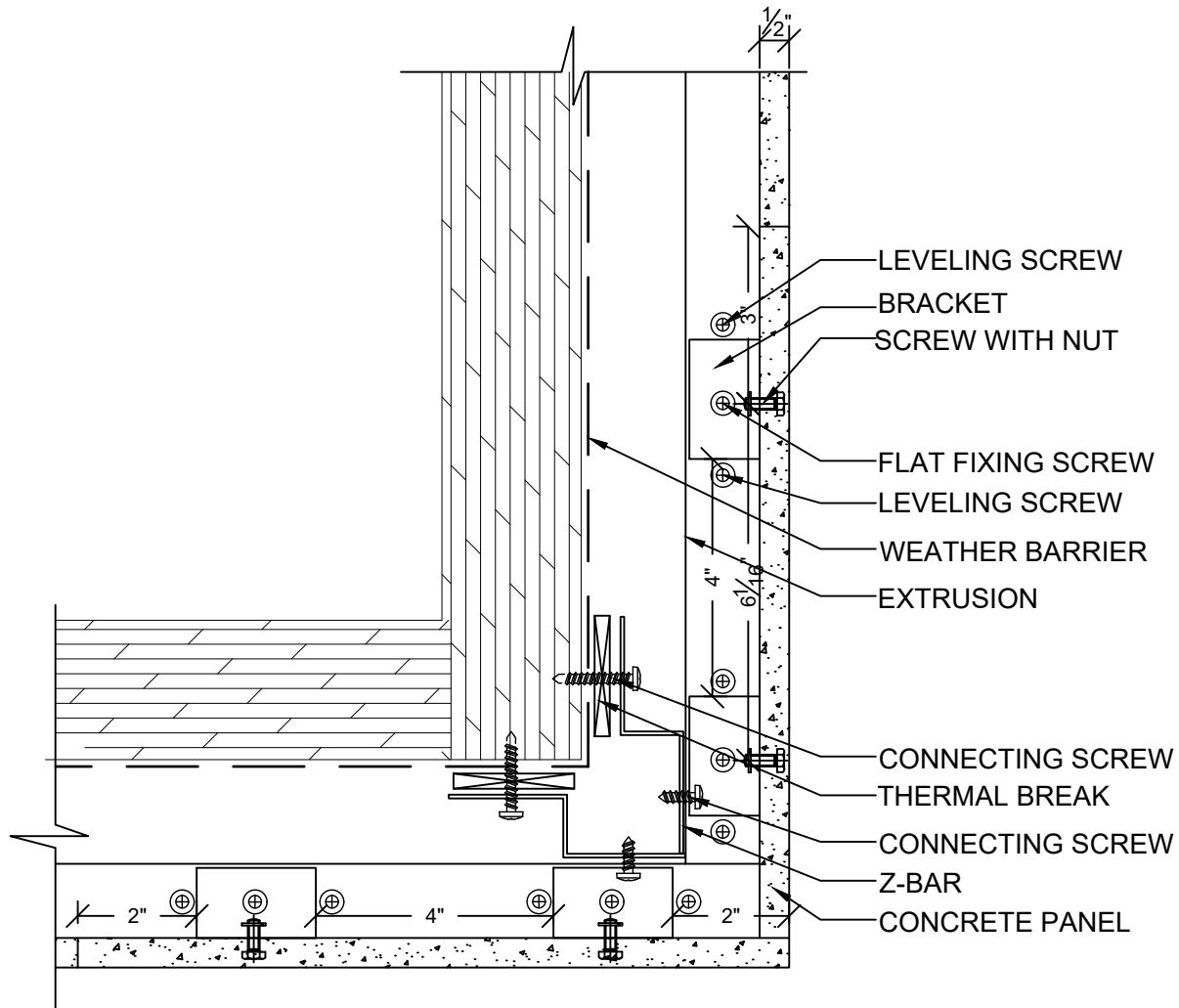

CONCRETE CORNER Details 6

SITE: XXX	XX DRAWING NO.	XX PROJECT NO.	MM,DD,YY DATE.		133 Romina Dr, Concord ON L4K 4Z9 Phone: 1(888)308-8898 email: info@nortem.ca www.nortem.ca
TITLE: CONCRETE DETAIL 6	8:1 SCALE AT A4.	AS DRAWN.	XX CHECKED.		